

Backflow Prevention

Cross-Connection Control Handbook

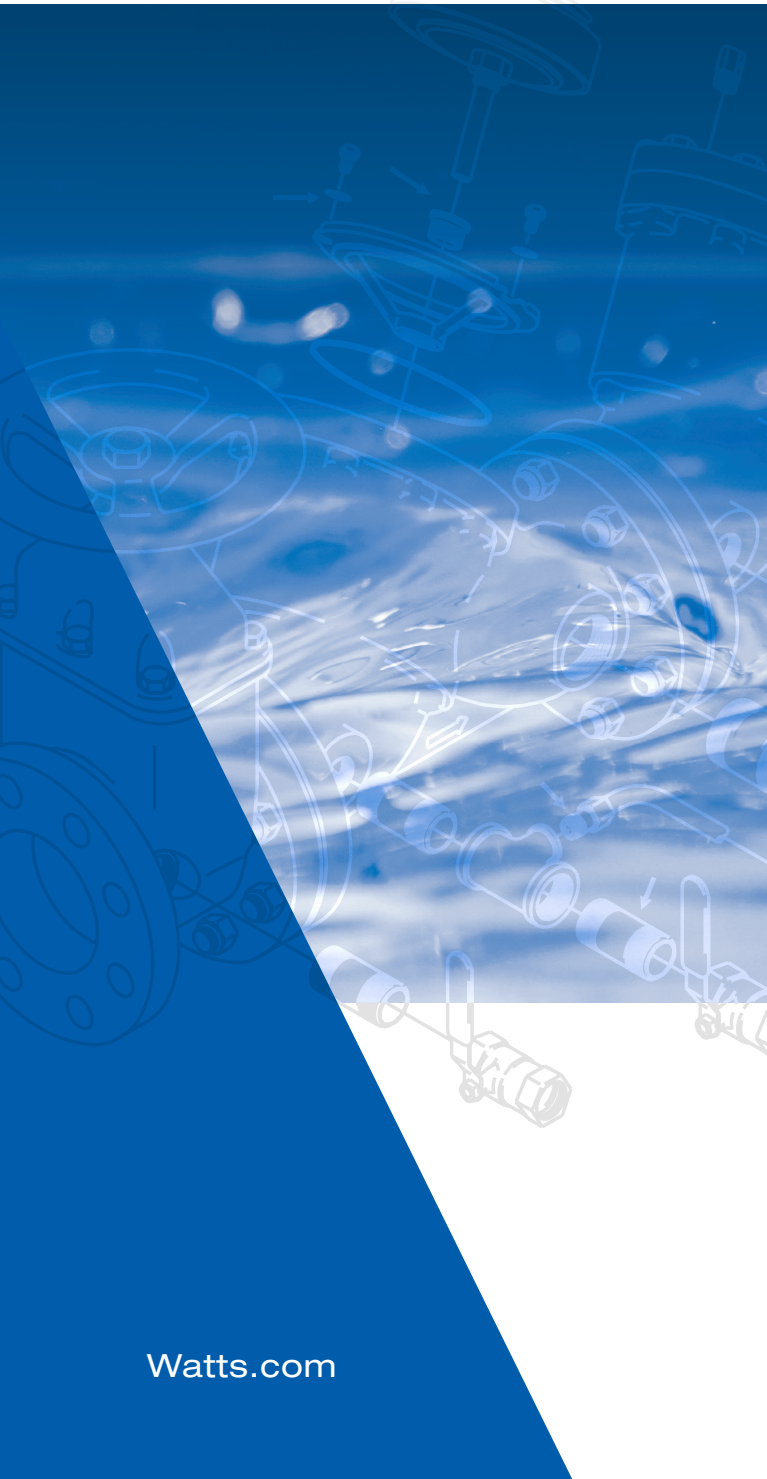

Contents

Backflow – What is it?.....	1
Case Histories	2 - 3
Typical Cross-Connections	4 - 5
Backflow Prevention Devices	6
How Backflow Prevention Devices Work	7
Device Selection	8
Installation	8 - 9
Testing	9

An informative booklet, for the purpose of a better dissemination of the facts about potential hazards to public health through backflow contamination.

A Brief History of Cross-Connection Control

Man has long recognized the need for pure drinking water, but only in the last 50 or 60 years has there been any real effort to prevent contamination caused by cross-connections.

Although double check valves came into use around the turn of the century to isolate fire mains and industrial water lines from the potable water supply, little interest was shown in the individual treatment of plumbing fixtures.

In 1929 the major breakthrough came when a device consisting of two check valves with a relief valve between them was successfully tested in Danville, Illinois. However, this valve was not produced commercially and it was not until the late 1930's that the real development of effective vacuum breakers and backflow preventers took place.

It was in this period that ordinances for cross-connection control began to be enforced. The Safe Drinking Water Act, signed into law by President Ford, placed more emphasis on the responsibility for drinking water protection.

The need for cross-connection control exists in all types of premises, whether industrial or residential. Backflow prevention devices help protect the public safety by preventing potable water contamination in such critical areas as municipal water systems, food processing plants, medical and dental water supplies, and many industrial applications.

Bibliography

"Cross-Connection Control Manual" (EPA-570/9-89-007)
U.S. Environmental Protection Agency, Water Supply Division, Washington D.C. (1973)

Recommended Practice for Backflow Prevention and Cross-Connection Control, AWWA M14, American Water Works Association, Denver, CO, 1990.

"Manual of Cross-Connection Control," Foundation for Cross-Connection Control and Hydraulic Research, University of Southern California; Los Angeles, Calif. 90007

American Society of Sanitary Engineering (ASSE), Professional Qualification Standards, Backflow Prevention Assemblies - Series 5000, Bay Village, Ohio.

Canadian Standards Association, Manual for Selection, Installation, and Field Testing, CAN/CSA-B64.10-94

Backflow... What is it?

Backflow? You may have heard of it, and you may understand some of what it involves. This booklet will help you to understand it better; exactly what it is, and how to prevent it.

Backflow is the undesirable reversal of the flow of water or mixtures of water and other undesirable substances from any source (such as used water, industrial fluids, gasses, or any substance other than the intended potable water) into the distribution pipes of the potable water system. There are two types of backflow conditions: backpressure and backsiphonage.

Backpressure: Occurs when the user system is at a higher pressure than the supply water systems allowing undesirable substances to be “pushed” back into the potable water system. Some causes are: booster pumps, potable water system connections for boilers, interconnection with other piping systems operating at higher pressures, or higher elevations in user systems such as high-rise buildings.

One specific example of this would be a steam heating system with the make-up water line piped directly into the boiler. The higher pressure in the boiler could force the chemically treated boiler water back through the make-up water line and into the potable water system.

Backsiphonage: Occurs when negative or reduced pressure exists in the supply piping allowing undesirable substances to be “drawn” into the potable water supply. Some causes are: undersized supply piping, supply line breaks, reduced supply system pressure on the suction side of an on-line booster pump, or sudden upstream high demand. An example of this is a child drinking milk with a straw. The child “sucks” on the straw and the milk flows up the straw and into the child’s mouth. What the child is actually doing is creating a subatmospheric pressure in his mouth and the atmospheric pressure (14.7psia at sea level) is pushing down on the surface of the milk and forcing the milk up the straw and into the child’s mouth.

There is one other very important term that must be understood before we can proceed. The term is “Cross-Connection,” and it is defined as any actual or potential connection between a potable water system and any other source or system through which it is possible to introduce into the potable system any used water, industrial fluid, gas, or other substance other than the intended potable water with which the system is supplied. By-pass arrangements, jumper connections, removable sections, swivel or change-over devices and other permanent or temporary devices through which, or because of which, backflow can or may occur are considered to be cross-connections.

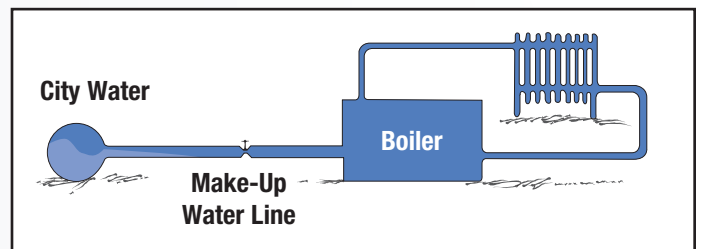

CASE HISTORIES

“All of this is very interesting, but does it REALLY happen?” you may ask. The answer to that is an emphatic YES! Below are listed some typical cases of backflow that actually occurred.

Case No. 1

The year was 1933. People from all over the world were crowding into one of America’s largest cities to see the “World’s Fair.” An epidemic of Amoebic Dysentery broke out and official records show that 98 people died and 1,409 others became seriously ill. Hundreds, possibly thousands of other affected people were never counted by investigating agencies since when they became ill, they went home. A special investigating committee of public health authorities found the main reason of this catastrophe to be “...old and generally defective plumbing and cross-connections potentially permitting backsiphonage from fixtures, such as bathtubs and toilets...”

Case No. 2

In December, 1964, a hospital in the State of Michigan had its potable water system contaminated. The cause was an unprotected autopsy table in the hospital’s morgue.

Case No. 3

It was in July of 1955 in San Pedro, California, a U.S. Navy Destroyer pumped salt water through five obsolete check valves into the street mains in a 90 square block of the town.

Case No. 4

This unusual death was caused by backsiphonage in a suburb of one of California’s largest cities. A man was spraying his lawn with a commercial weed killer that contained an arsenic compound. His applicator was an aspirator device on his garden hose, to which was attached a bottle of the arsenic poison. When he had finished spraying, the man turned off the hose, disconnected the applicator, and since it was a warm day, turned the hose on again to get a drink of water. A short time later, he was dead from arsenic poisoning. At some time while he was spraying, a backsiphonage condition had occurred and the arsenic was carried back into the hose.

Case No. 5

In 1969 in Utah, raw irrigation water was pumped through a farm standby irrigation connection into over half of the entire town’s potable water system. The standby connection was not protected with a backflow prevention device.

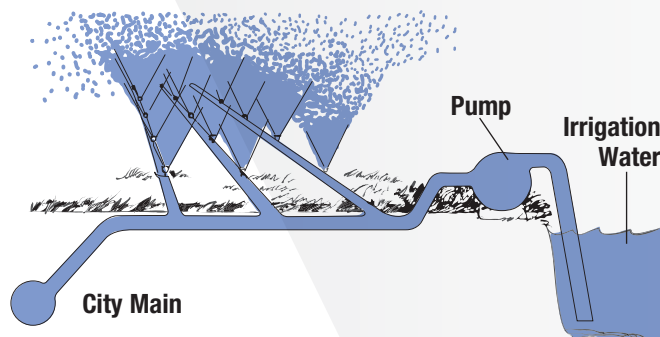
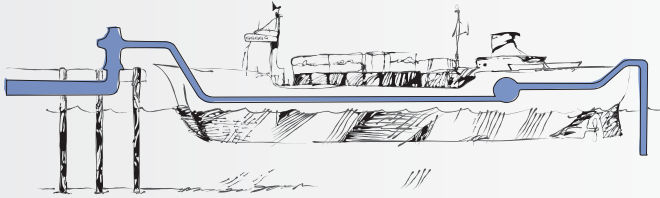

CASE HISTORIES

Case No. 6

In August, 1969, 83 football team members and coaching staff were stricken with infectious hepatitis due to subsurface hose bibs and a nearby fire. The fire trucks in fighting the fire reduced the main pressure enough to cause backsiphonage from the hose bibs.

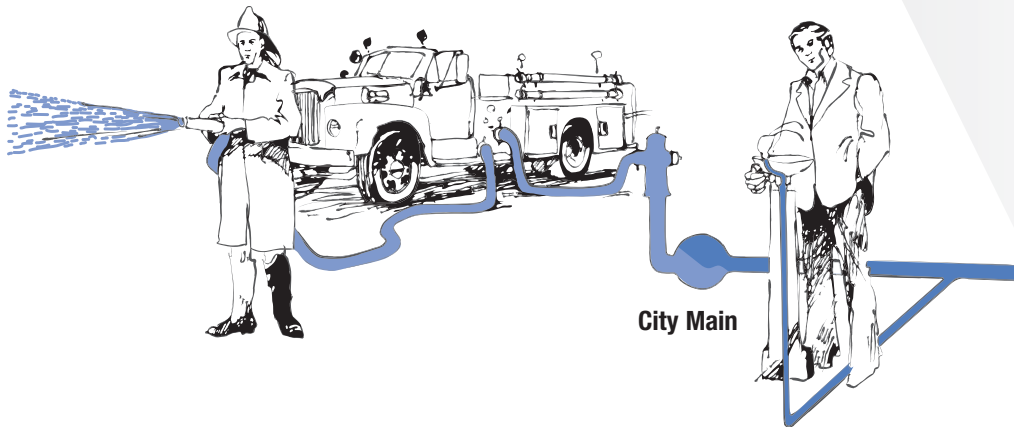

Case No. 7

In the summer of 1970 in New Jersey, a soft drink vending machine in the Caddy house of a golf club was connected to the building heating system in which hexavalent chromium had been added. Eleven cases of nausea were reported by the caddies.

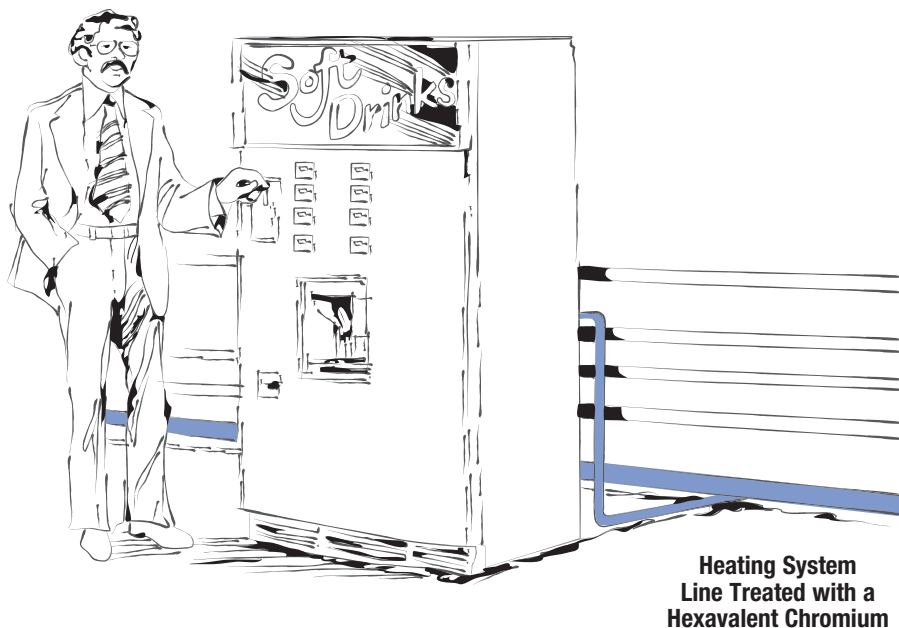

TYPICAL CROSS-CONNECTIONS

Spray Hose in Sink

This type of cross-connection is commonly found in the food industry and in janitor's sinks. A hose has been connected to the faucet on the sink. When the faucet is left running, a loss in pressure of the supply main can siphon this used water back into the potable water system.

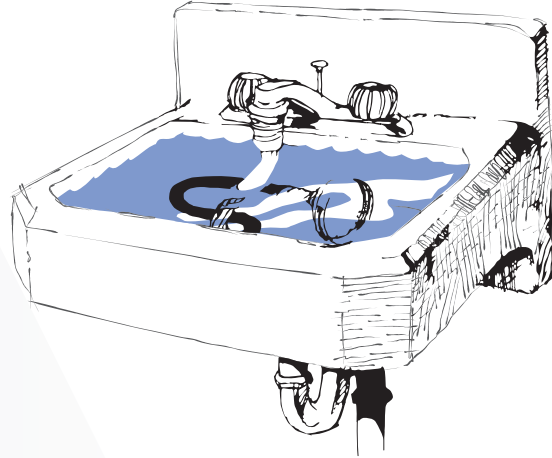

Submerged Inlets

In many industrial installations that use chemically treated baths, the make-up water line runs directly into the tank. If there is backsiphonage, the toxic chemicals can be sucked back into the potable water system.

Hose Bibs

At first glance, a hose bib seems innocuous, but it is the things people do with the hose that creates problems. In this example, a man is trying to blow a stoppage out in a sewer line, but with a sudden drop in line pressure, this contaminated water can be backsiphoned into the potable water system.

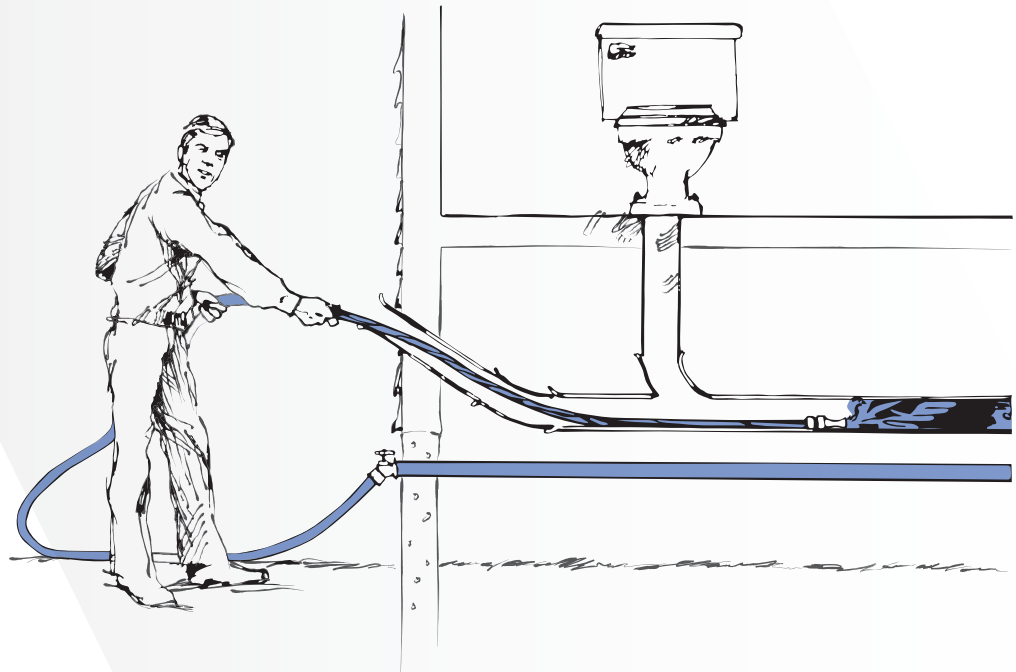
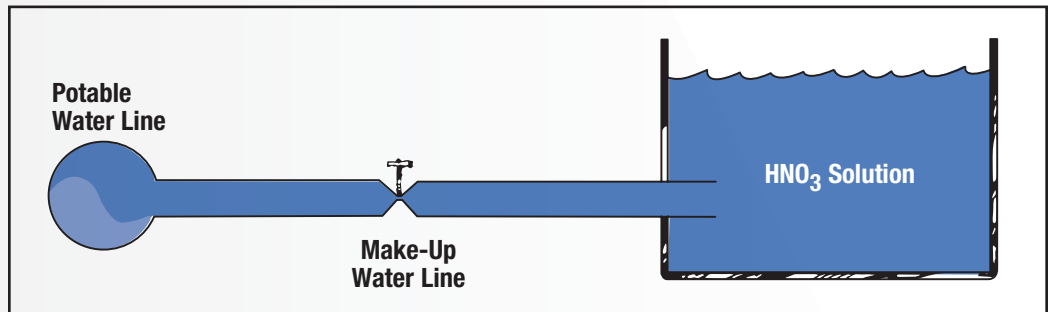

TYPICAL CROSS-CONNECTIONS

Lawn Sprinklers

On a large number of lawn sprinkler installations, the sprinkler head is below the ground level. Water which may have been in contact with fertilizers and weed killers can then be back-siphoned through a leaky valve into the potable water system.

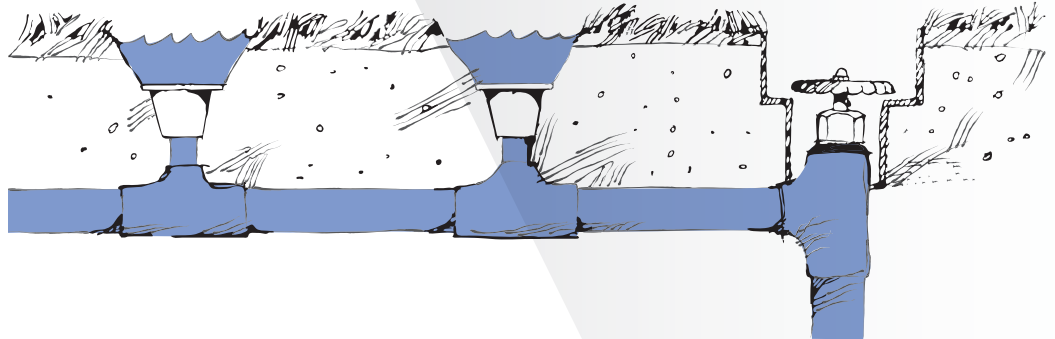

Irrigation Pumping Systems

On many farms water is pumped from irrigation water channels into the sprinkler system. A large number of these installations are also connected to the domestic water system for times when there is little or no irrigation water available. It is possible that the pump develops more pressure than there is in the domestic supply main and the irrigation water can then be pumped through a leaky or partially open crossover valve.

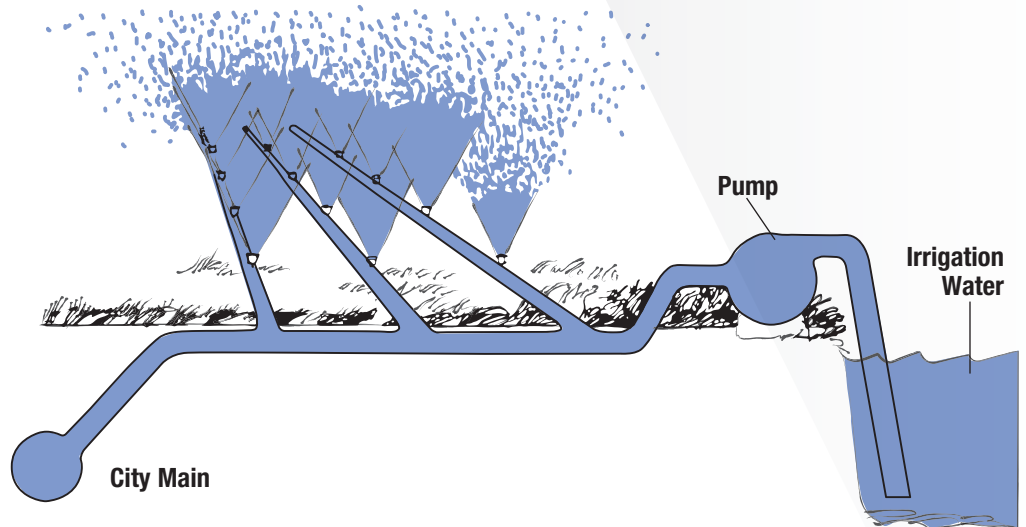

Fire Sprinkler Systems

On a large number of fire sprinkler systems, there is a hook up connection for the fire truck pumper to increase pressure and flow in the sprinkler system. At times a "wetting agent" is added to the water to increase the effectiveness of the water in combating the fire. If the system is not protected, it is possible for the pumper to pump this "wet" water back into the city's domestic water supply.

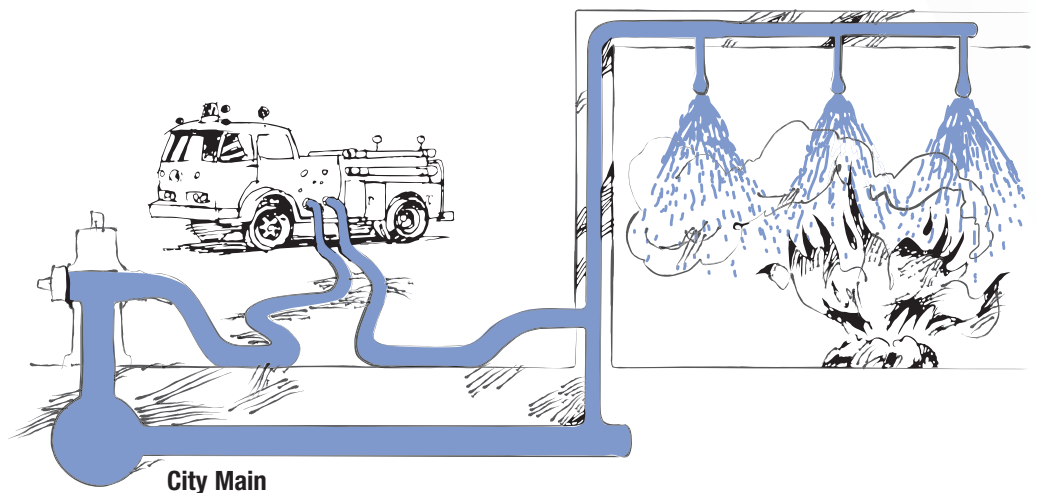

BACKFLOW PREVENTION DEVICES

There are several different types of mechanical backflow prevention device. An alternative to a mechanical device, is a physical separation, or air gap. The air gap is a physical break in the system. The different types, of mechanical device, are used in different situations (if there is backpressure or backsiphonage) and for different degrees of hazard.

The degree of hazard is based on the fluid (or other substance) that may backflow into the supply piping system. The fluid may be toxic or nontoxic and could create a “non-health” or “health” hazard.

A non-health (non-toxic) hazard cross-connection is any point on a water supply system where a polluting substance may come in contact with potable water aesthetically affecting the taste, odor or appearance of the water, but not hazardous to health.

A health hazard (toxic) cross-connection is any point on a water supply system where a contaminating substance may come in contact with potable water creating an actual health hazard, causing sickness or death.

Double Check Valve Assembly (DC)

The double check valve assembly (DC) is composed of two single, independently acting check valves. The unit also has two tightly closing, resilient seated, shutoff valves located at each end of the device and four test cocks for the testing of the check valves.

Reduced Pressure Principal Assembly (RP)

Commonly referred to as an RP or RPP, this device consists of two independently acting check valves, together with an automatically operating pressure differential relief valve located between the two check valves. The first check valve reduces the supply pressure at a predetermined amount so that during normal flow, and at cessation of normal flow the pressure between the two check valves shall be lower than the supply pressure. If either check valve leaks, the relief valve will discharge to atmosphere. This will maintain the pressure in the zone between the two check valves lower than the supply pressure. The unit also has two, resilient seated, shutoff valves (one upstream and one downstream of the checks) and properly located test cocks for field testing.

Pressure Vacuum Breaker (PVB)

The pressure vacuum breaker (PVB) is a device that contains within a single body, a single loaded check valve and a loaded air opening valve which opens to admit air whenever the pressure within the body of the device approaches atmospheric. The device has two tight closing, resilient seated, shut-off valves, and it is fitted with test cocks, appropriately placed, for testing the device.

Dual Check Valve (DuC)

The dual check (DuC) is a device which has two single, independent acting check valves in series. It does not have any testcocks and is generally not field tested.

Dual Check with Atmospheric Port (DCAP)

This device has two independent acting check valves with a relief valve located between the checks. The device is not testable and should only be used for lower degrees of hazard.

Atmospheric Vacuum Breaker (AVB)

An atmospheric vacuum breaker (AVB) is a device which has a moving element inside, which during flow prevents water from spilling from the device and during cessation of flow, drops down to provide a vent opening. This device should not remain under pressure for long durations, and it cannot have any shutoff valve downstream of it.

Air Gap

An air gap is a physical separation between the free flowing discharge end of a potable pipe line and an open or non-pressure receiving vessel. To have an acceptable air gap, the end of the discharge pipe has to be at least twice the diameter of the pipe above the topmost rim of the receiving vessel, but in no case can this distance be less than one inch.

This may seem to be the simplest, most effective and least expensive type of protection. However, the chance for future cross-connections, the cost of additional pumps to pressurize the system often makes this an expensive protection system.

Spill-Resistant Vacuum Breaker (SVB)

The valve shall consist of a one-piece modular check valve force-loaded closed and an air inlet valve forced loaded open to atmosphere, positioned downstream of the check valve, and located between two (2) tightly closing shut-off valves and two (2) test cocks.

HOW BACKFLOW PREVENTION DEVICES WORK

This figure shows an RP device during a backsiphonage condition. If you will notice, both checks are closed tight and the pressure differential relief valve is discharging to atmosphere. This is due to the fact that the relief valve is designed to maintain a lower pressure in the zone between the two check valves than the supply pressure.

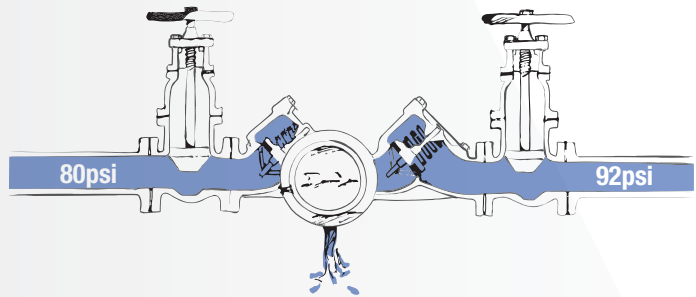

In this figure of an RP device, there is a backpressure condition. The second check is fouled with a piece of pipe scale which permits the higher pressure to flow back into the zone. Here the relief valve discharges the water to atmosphere maintaining the pressure in the zone lower than the supply pressure.

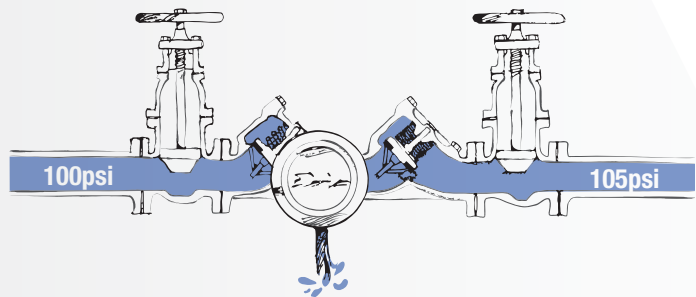

In this view of a pressure vacuum breaker, a backsiphonage condition has caused the check to close against its seat and the air-inlet has opened so that the pressure in the body of the device is atmospheric. If the check was fouled by some foreign material, only air would be pulled back into the domestic supply system instead of the non-potable water downstream of the device.

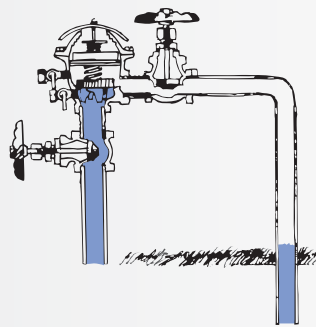

In this picture of an atmospheric vacuum breaker, a backsiphonage condition exists. This condition has caused the check-float to drop away from the air-inlet and seat on the check seat, which prevents the non-potable water from being backsiphoned. If the check-float did not seat properly, again only air would be sucked back into the domestic water system.

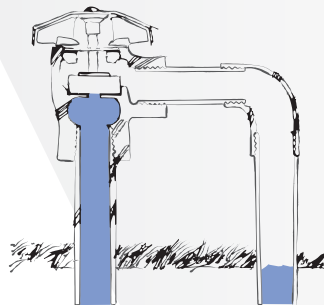

In this view of a double check valve, there is backpressure from a source downstream which has caused the second check to close tightly against this reverse pressure. The first check has closed tightly by itself, thus giving two barriers against the backflow condition.

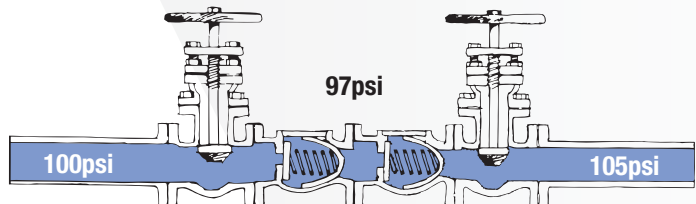

DEVICE SELECTION

The selection of the proper type of device is important. Depending upon the fluid that can backflow, whether it is toxic or non-toxic; and whether there can be backpressure or backsiphonage; it will govern the type of device selected. The following chart will help you to decide what type of device to use.

- RP** - Reduced Pressure Assembly
- DC** - Double Check Assembly
- PVB** - Pressure Vacuum Breaker
- AVB** - Atmospheric Vacuum Breaker
- DuC** - Dual Check
- DCAP** - Dual Check with Atmospheric Port

	RP	DC	PVB	AVB	DuC	DCAP
Continuous Pressure	✓	✓	✓		✓	✓
Possible Back-pressure	✓	✓			✓	✓
Possible Back-siphonage	✓	✓	✓	✓	✓	✓
Nontoxic	✓	✓	✓	✓	✓	✓
Toxic	✓		✓	✓		

INSTALLATION

Having a device on the connection is not enough, the device **MUST** be installed correctly. The following details and illustrations will help you in the proper installation of the devices.

Reduced Pressure Device

In these figures, the RP device is shown on the service connection. The RP can also be used for internal protection. The minimum clearance of 12" above the floor or grade is to ensure an air gap between the relief valve and any water that might puddle beneath the device. The maximum height is so that the device will be easy to work on during testing and maintenance. If the device is in a protective enclosure or mounted against a wall, the minimum distances are so that the device can be tested and maintained.

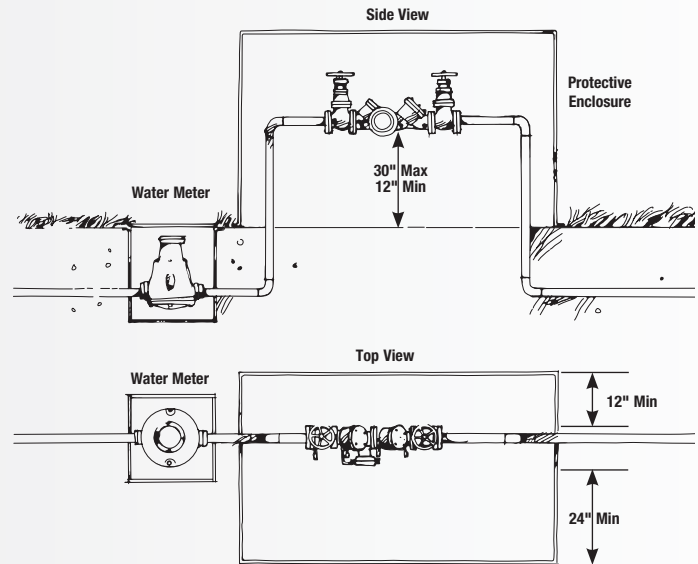

INSTALLATION

Double Check Valve

In these figures, the double check assembly is shown on the service connection, it can also be used for internal protection as well. The minimum and the maximum distances are the same as they are for the RP device.

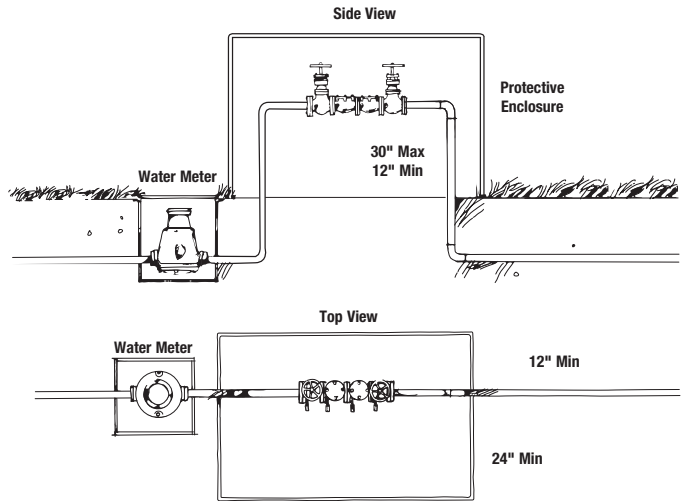

Dual Check

The dual check is usually installed immediately downstream of the water meter in residential installations (not shown).

Pressure Vacuum Breaker

The pressure vacuum breaker cannot be installed where there can be backpressure. It should only be used where there may be backsiphonage. The pressure vacuum breaker can have shutoff valves downstream of the device. The PVB must be installed at least 12" above the highest outlet or, if it is feeding an open tank, at least 12" above the highest overflow rim of the tank. The following figure shows a typical installation on a sprinkler system.

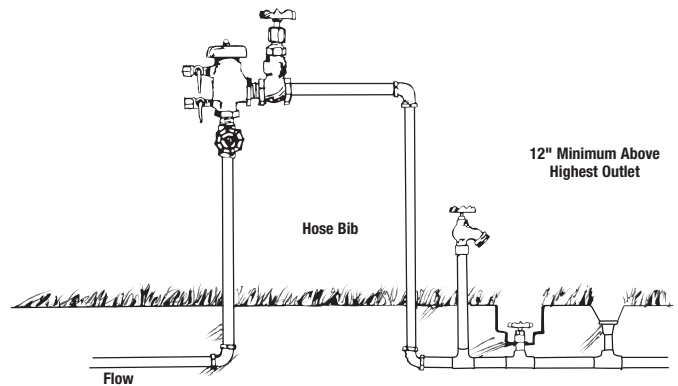

Atmospheric Vacuum Breaker

Just as the pressure vacuum breaker, the atmospheric vacuum breaker cannot be installed where there can be backpressure, only where there can be backsiphonage. The atmospheric vacuum breaker cannot have any shutoff valves downstream of it. It also must be installed at least 6" above the highest outlet or the topmost overflow rim of a nonpressure tank. The following illustration shows the AVB on a sprinkler system.

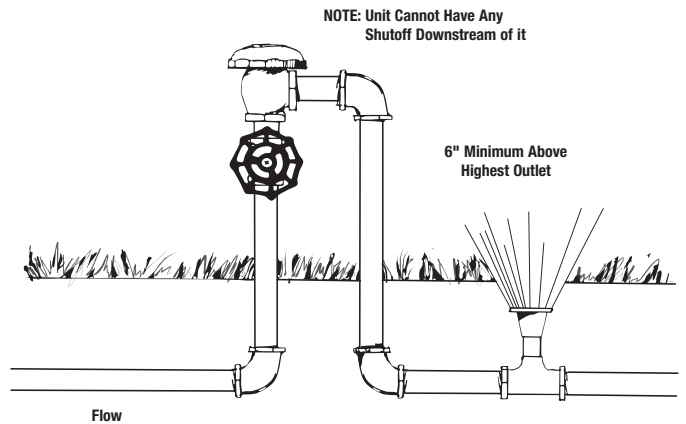

TESTING

All mechanical devices should be inspected on a regular basis to ensure they are working correctly. Pressure vacuum breakers, double check and reduced pressure principle assemblies should be tested at time of initial installation and annually thereafter. Acceptable test procedures are published by The University of Southern California (USC), The American Water Works Association (AWWA), The American Society of Sanitary Engineering (ASSE Series 5000), and The Canadian Standards Association (CAN/CSA B64.10). Please consult the regulatory authority in your area for more specific information.



TOGETHER, THREE WATTS BRANDS PROVIDE SOLUTIONS FOR A BROAD ARRAY OF BACKFLOW PREVENTION APPLICATIONS.