

# Installation, Operation and Maintenance Manual

## Single-Stage Lead Filtration System

Model: PWDWHCL1



**WARNING**



Please read carefully before proceeding with installation. Your failure to follow any attached instructions or operating parameters may lead to the product's failure. Keep this Manual for future reference.



**WARNING**

Do not use with water that is microbiologically unsafe or of unknown quality without adequate disinfection before or after the system.

**IMPORTANT**

If you are unsure about installing your WATTS water filter, contact a WATTS representative or consult a professional plumber.

**CAUTION**

Test the water periodically to verify that the system is performing satisfactorily.

Discard small parts remaining after the installation.

**NOTICE**

Failure to install the system correctly voids the warranty. Handle all components of the system with care. Do not drop, drag or turn components upside down.

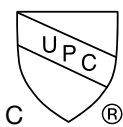
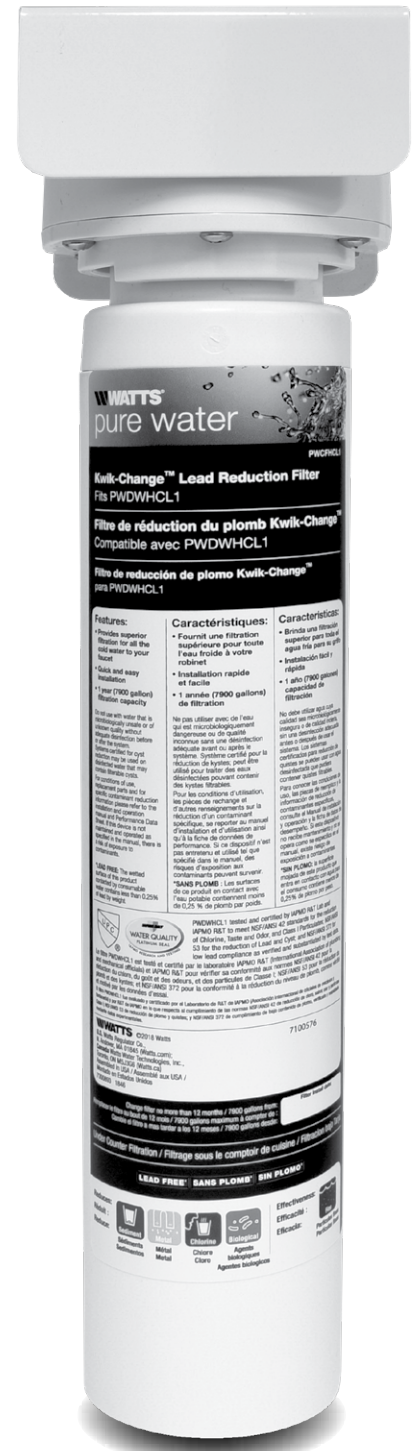

PWDWHCL1 tested and certified by IAPMO R&T Lab and IAPMO R&T to meet NSF/ANSI 42 standards for the reduction of Chlorine, Taste and Odor, and Class I Particulates; NSF/ANSI 53 for the reduction of Lead and Cyst; and NSF/ANSI/CAN 372 for low lead compliance as verified and substantiated by test data.

PWDWHCL1

Refer to enclosed warranty for operating parameters to ensure proper use with your water supply.



# Overview

Thank you for your purchase of a state of the art Water Treatment system.

Your new system is equipped with a high capacity Carbon Fiber filter with Lead, Cyst, Sediment and Chlorine reduction capability. The PWDWHCL1 water filtration unit provides clean, clear, great tasting water to your existing faucet and has a 7,900 gallon filtration capacity. System is certified to reduce Lead, Cyst, Sediment and Chlorine.

Simple under sink installation, only requiring standard household tools, allows changing of the filter with just a quarter turn.

# System Maintenance

It is important to change filters at the recommended interval indicated in this manual. Many contaminants are not detectable by taste. In addition, other bad tastes and odors may become apparent over time if filters are not replaced.

When replacing any of the filter elements, pay special attention to any cleaning instructions. Should you have any further questions, please visit our website at [www.watts.com/purewater](http://www.watts.com/purewater) or call our Pure Water Customer Service or Technical Support Team at 1.800.224.1299.

# Operational Parameters

**NOTICE**  
**Installation must comply with state and local plumbing regulations.**

	Maximum	Minimum
<b>Operating Temperature:</b>	100°F (37.8°C)	35°F (1.7°C)
<b>Operating Pressure:</b>	125 psi (862 kPa)	10 psi (69 kPa)
<b>pH Parameters:</b>	10	5
<b>Flow Rate:</b>	2.0 gpm	

# Table of Contents

- Overview . . . . . 2
- System Maintenance . . . . . 2
- Operational Parameters . . . . . 2
- Installation Pre-Cautions . . . . . 2
- Contents of Under Counter System . . . . . 2
- Recommended Tools For Installation . . . . . 3
- System Diagram . . . . . 3
- Parts List . . . . . 3
- Kitchen Faucet Adapter Connection . . . . . 3
- Cartridge Installation . . . . . 3
- System Module Mounting . . . . . 4
- Inlet and Outlet Tube Connection - Filtration System . . . . . 4
- Using Quick-Connect Fittings . . . . . 4
- System Start up . . . . . 5
- Product Registration . . . . . 5
- Annual Maintenance . . . . . 5
- Trouble Shooting . . . . . 5
- Performance Data sheet . . . . . 6
- Service Record . . . . . 7
- Limited Warranty . . . . . 8

# Installation Precautions

**NOTICE**

- System is intended to be installed on the cold water line ONLY. Do not use hot water supply
- Do not install if your water lines are susceptible to water hammer
- System to be used with municipal or well water sources properly treated and tested on regular basis in insure suitable and non-adverse water conditions, including bacteriological safe quality.
- Filter housing must be protected against freezing temperatures, frost, snow, sleet and ice. Exposure to these elements can damage the housing and lead to water damage.
- This product has a limited service life. We recommend that a record be kept regarding the date of install and any other performance maintenance. Because of the products' limited service life and to prevent costly repairs or possible water damage, we strongly recommend that the head be replaced every ten years.
- Turn off water supply to head and remove the cartridge if it must be left unattended for an extended period of time.
- After prolonged periods of non-use (such as vacation) it is recommended that the system be flushed thoroughly. Let water run 5 - 6 minutes before using
- The filter recommended for use with this system carries a limited service life. Changes in taste, odors, color and/or flow of the water being filtered indicates that the cartridge should be replaced.
- Make certain that installation complies with all state and local laws and regulations.
- If you have anything other than flexible hose under your sink, check to see if you need to purchase special fittings prior to starting install.

# Contents of Under Counter System

**Please make sure all of the items listed below are contained in the box. If any of the items are missing please contact Customer Service at (800) 224-1299 prior to installing.**

- System Head with Attachable Bracket
- Model #PWCFHCL1 Kwik-Change™ Filter in separate box inside system box
- 3/8" Kitchen Faucet Adapter
- Mounting Screws
- 3/8" Plastic Tubing

## Recommended Tools For Installation

- Small knife or tube cutter
- Variable speed drill
- 1/8" (3mm) drill bit
- Adjustable wrench
- Phillips screwdriver

## System Diagram

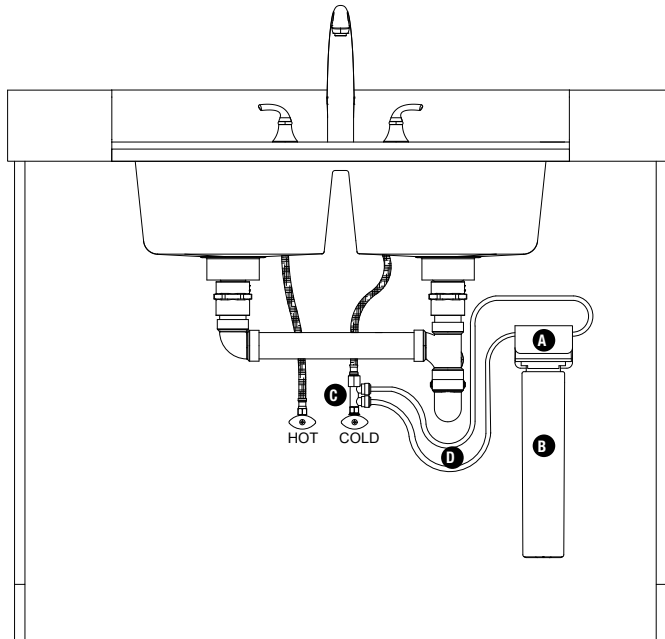

## Parts List

Item	Description
A	System Head with Attachable Bracket
B	High Capacity Kwik-Change™ Lead Filter
C	Kitchen Faucet Adapter
D	3/8" Plastic Tubing
E	Mounting Screws not shown (x2)

## Kitchen Faucet Adapter Connection

### ⚠ CAUTION

Water supply line to the system must be from the cold water supply line only. Hot water will severely damage your system.

Step 1 - Turn off the cold water supply to the faucet by turning the angle stop valve completely off.

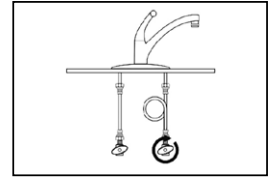

Step 2 - Open cold water sink faucet to relieve pressure.

Step 3 - Place a small container under the cold water angle stop valve to catch any runoff water. Disconnect the cold water faucet supply hose from the cold water angle stop valve.

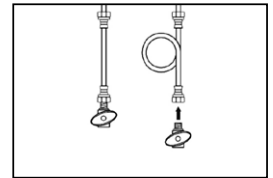

Step 4 - Hand-tighten the kitchen faucet adapter to the cold water angle stop valve as shown. Next hand-tighten the lower end of the cold water line onto the top of the kitchen faucet adapter.

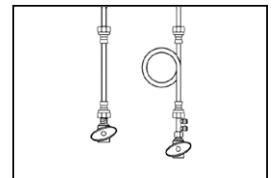

## Cartridge Installation

Step 1 - Line up arrow on cartridge with unlocked position on head, insert cartridge and turn to locked position.

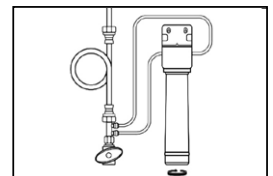

## System Module Mounting

Step 1 - Mount the system to one side of the cabinet allowing 2" of clearance below the filter for easy filter removal and replacement.

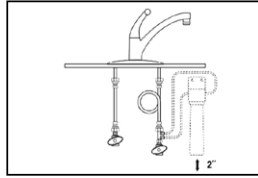

Step 2 - Using the mounting bracket, mark with a pencil the holes for the mounting screws on the wall surface.

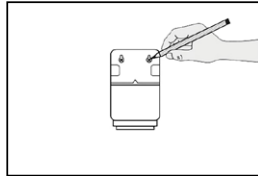

Step 3 - Using a 1/8" drill bit, drill pilot holes for the mounting screws. Insert mounting screws into the wall with a screwdriver leaving approximately 3/8" of each mounting screw exposed and hang system head on the mounting holes of the bracket.

## Inlet and Outlet Tube Connection - Filtration System

Step 1 - Determine two different lengths of 3/8" tubing needed to connect the system head inlet and outlet to the kitchen faucet adapter (reference image for inlet and for outlet locations and directions on the right for cutting and installing tubing). Be sure to allow enough tubing to prevent kinking in the line.

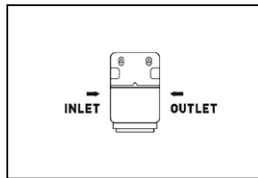

Step 2 - Wet one end of the 3/8" plastic tubing with water and push it into the inlet side of the system head approximately 5/8" until it stops. Connect the other end of the tubing to the inlet side of the kitchen faucet adapter. Refer to Quick-Connect instructions on the right for more detail.

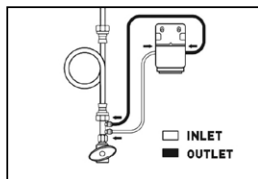

Step 3 - Repeat same process with outlet side.

### **NOTICE**

**Reference image for inlet and outlet locations.**

## Using Quick-Connect Fittings

### Cutting

Cut the tube square. It is essential that the outside diameter be free of score marks, and that burrs and sharp edges be removed before inserting into fitting.

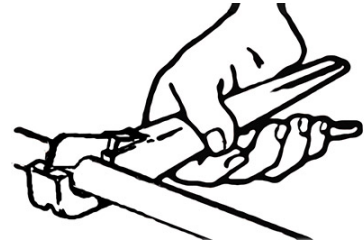

### Connecting

Make certain to push the tubing completely into the connector until it comes into contact with the internal tubing stop. The collet (gripper) has stainless steel teeth which hold the tube firmly in position while the O-ring provides a permanent leak proof seal.

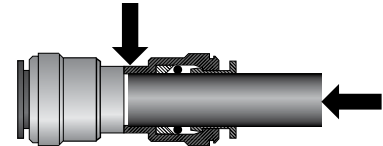

Pull on the tube to check that it is secure. The system must be tested prior to leaving the site and/or before use.

### Disconnecting

To disconnect, ensure the system is depressurized before removing the tube. Push in collet squarely against the face of the fitting. With the collet held in this position, the tube can be removed. The fitting can then be reused.

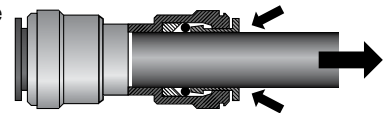

## System Start Up

**Step 1** - Turn on water supply at cold water angle stop. Turn cold water faucet handle to the open position to start the flow of water through the unit. Run 20 gallons of water through the unit in order to flush out the normal black carbon fines (it will "sputter" until the air is purged out) from the unit. A container with a known volume can be filled to determine how much water has flushed through the system. Initially, the water may appear cloudy which is due to tiny air bubbles and it will clear up shortly. Close the faucet when finished.

**Step 2** - Check for leaks. If you have any leaks, shut off the water supply to your system, tighten any fittings then turn the supply back on.

### NOTICE

**Check frequently over the next 24 hours to ensure no leaks are present**

## Product Registration

To Register your product, please visit [www.watts.com/purewater](http://www.watts.com/purewater) and select "Register Now". Registration is in accordance with our Privacy Policy and Terms of Use.

See our Privacy Policy at - <http://www.watts.com/privacy.asp>

See Terms of Use at - <http://www.watts.com/terms.asp>

## Annual Maintenance

**Annual Filter: Kwik-Change™ Lead Reduction Filter**

**(12-Months - PWCFHCL1, EDP#7100576)**

**Remove completely and buy replacement.**

**Step 1** - Turn off incoming water supply to the filtration unit.

**Step 2** - Open the cold water faucet handle to relieve the water pressure.

**Step 3** - Remove the filter from the head by turning to the left, then pulling downwards. Discard the old filter.

**Step 4** - Remove filter cartridge from filter cartridge box inside system box

**Step 5** - To install new filter cartridge, with the filter label facing approximately 45 degrees to the left, push the filter into the filter head and twist it to the right until the filter locks in and the label on filter is facing the front.

**Step 6** - Follow start-up procedure.

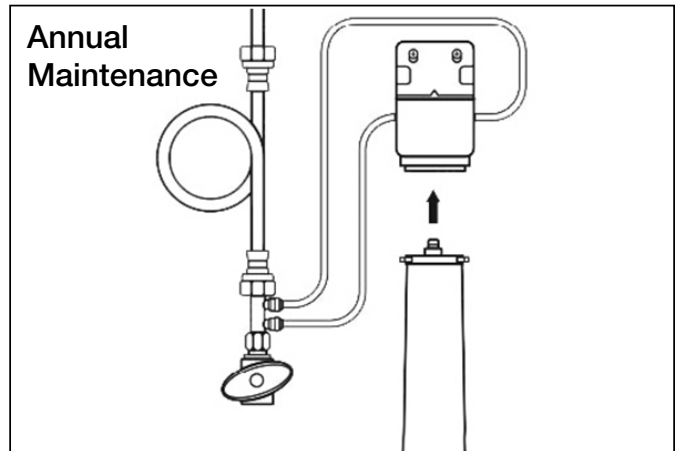

### NOTICE

**Mark the date the filter is installed on cartridge label**

## Troubleshooting

### LEAKS BETWEEN THE SYSTEM HEAD ASSEMBLY AND THE FILTERS:

1. Turn off water supply to the filter and dispense water from kitchen faucet until water and airflow stops.
2. Remove cartridge and inspect O-rings to make sure they are in place and clean.
3. Install cartridge, turn on water supply and check for leaks.

### LEAKS AROUND THE FITTINGS:

1. Turn off water supply to the filter to relieve pressure.
2. While pulling the 3/8" plastic tubing with one hand, press in on the collar around the inlet and/or outlet fitting. Check to make sure that the 3/8" plastic tubing is cut squarely and that it is not scratched or crimped. If the 3/8" plastic tubing is unevenly cut or scratched, cut off 1/2" to 5/8" and re-install tubing.
3. Turn on water supply and check for leaks.

### LEAKS ON THE KITCHEN FAUCET ADAPTER CONNECTION:

1. Turn off water supply to the filter to relieve pressure.
2. Locate the kitchen faucet adapter.
  - If the 3/8" plastic tubing is leaking, follow the previous steps ("Leaks around the fittings").
  - If the thread between the kitchen faucet adapter and cold water line is leaking, tighten more securely. If leaking continues, apply plumbers tape to threads and tighten.
3. Turn on water supply and check for leaks.

**If leaks persist, or if there are other leaks on system, turn off water supply. Contact Customer Service or Technical Support Team at 1.800.224.1299**

# Performance Data Sheet

## Watts pure water

In U.S.-Watts Regulator Co.,  
N. Andover, MA 01845 (Watts.com);

In Canada-Watts Water Technologies (Canada), Inc., Burlington, ON L7L 5H7 (Watts.ca)

## Single-Stage Lead Filtration System - PWDWHCL1

### GENERAL USE CONDITIONS

#### **⚠ WARNING**

1: System to be used with municipal or well water sources treated and tested on regular basis to insure bacteriological safe quality. DO NOT use with water that is microbiologically unsafe or of unknown quality without adequate disinfection before or after the system. While testing was performed under standard laboratory conditions, actual performance may vary. Systems certified for cyst reduction may be used on disinfected waters that may contain filterable cysts.

2: Operating Temperature: Maximum 100°F (38°C) Minimum 35°F (1.7°C)

3: Operating Water Pressure: Maximum 125-psi (861.85kpa) Minimum 10-psi (69kpa)

4: Maximum Flow Rate: 2 gpm (7.57 lpm)

5: Rated Capacity Lead: 7,900 gallons (29,904 liters)

6: Rated Capacity Cyst: 7,900 gallons (29,904 liters)

7: Rated Capacity Chlorine: 7,900 gallons (29,904 liters)

8: Rated Capacity Particulate (sediment): 7,900 gallons (29,904 liters)

### RECOMMENDED REPLACEMENT PARTS AND CHANGE INTERVAL:

Depending on incoming feed water conditions replacement time frame may vary.

Description	Model / Part Number	Change time Frame
Kwik-Change™ Lead Reduction Filter	PWCFHCL1 / 7100576	12 Months or 7,900 Gallons

The PWDWHCL1 system has been tested according to NSF/ANSI 42, 53, for reduction of the substances listed below. The concentration of the indicated substances in water entering the system was reduced to a concentration less than or equal to the permissible limit for water leaving the system, as specified in NSF/ANSI 42 and 53, and substantiated by test data. This system is certified to NSF/ANSI/CAN 372 for 'lead free' compliance.

Substance	Average Influent	NSF/ANSI Influent Challenge Concentration	Percent Reduction Requirement/Maximum Permissible Product Water Concentration	Average % Reduction	Average Product Water Concentration
<b>NSF/ANSI 42 — Aesthetic Effects</b>					
Chlorine	2.01 mg/L	2.01 mg/L ± 10%	≥ 50%	>94.8%	0.103 mg/L
Particulate, Class I particles 0.5 to < 1 µm	3,666,667 particles/mL	At least 10,000 particles/mL	≥ 85%	99.2%	28,017 particles/mL
<b>NSF/ANSI 53 — Health Effects</b>					
Cyst	71,500/L	Minimum 50,000/L	> 99.95%	99.99%	4.88/L
Lead pH 6.5	0.161 mg/L	0.15 mg/L ± 10% mg/L	0.005 mg/L	98.8%	0.0019 mg/L
Lead pH 8.5	0.15 mg/L	0.15 mg/L ± 10% mg/L	0.005 mg/L	98.05%	0.0029 mg/L

Not all water will contain contaminants listed. Testing performed under standard laboratory conditions; actual performance may vary. Filter usage must comply with all state and local laws. Filter is only to be used with cold water. Do not use with water that is microbiologically unsafe or of unknown quality without adequate disinfection before or after the system. Systems certified for cyst reduction may be used on disinfected water that may contain filterable cysts.

# Service Record

Date of Purchase: \_\_\_\_\_ Model Number: \_\_\_\_\_ Serial Number: \_\_\_\_\_

Date of Install: \_\_\_\_\_ Installed by: \_\_\_\_\_

<b>High Capacity Kwik-Change™ Carbon filter (12 Months)</b>		



## Limited Warranty

### What Your Warranty Covers:

Watts warrants your PWDWHCL1 (excluding replaceable filters) to be free from defects in material and workmanship under normal usage for a period of one year from the date of original purchase. If any part of this system is found to be defective within the warranty period, return the system after obtaining a return authorization from Watts (see below), and Watts will repair, or at Watts' option, replace the system at no charge.

### How to Obtain Warranty Service:

To obtain warranty service, call 1.800.224.1299 for a return authorization number. Then, ship your system to our factory, freight and insurance prepaid, with proof of the date of original purchase. Please include a note stating the warranty problem. Watts will repair, or at Watts' option, replace the system and ship it back to you at no charge.

### What this Warranty Does Not Cover:

This warranty does not cover defects resulting from improper installation (installation contrary to Watts printed instructions), abuse, misuse, misapplication, improper maintenance, neglect, alteration, accidents, casualties, fire, flood, freezing, environmental factors, water pressure spikes, adverse water conditions or other events or conditions beyond Watts' control.

This warranty will be void if defects occur due to failure to observe the following conditions:

1. The system must be hooked up to a potable municipal or well cold water supply.
2. The pH of the water must not be lower than 5 or higher than 10.
3. The incoming water pressure must be between 10 and 125 pounds per square inch.
4. Incoming water to the system cannot exceed 100 degrees F (38 degrees C.)

This warranty does not cover any equipment that is relocated from the site of its original installation.

This warranty does not cover any charges incurred due to professional installation.

### Other Conditions:

If Watts chooses to replace the system, Watts may replace it with reconditioned equipment. Parts used in repairing or replacing the system will be warranted for 90 days from the date the system is returned to you or for the remainder of the system's original warranty period, whichever is longer. This warranty is not assignable or transferable.

### Limitations and Exclusions:

THE WARRANTY SET FORTH HEREIN IS GIVEN EXPRESSLY AND IS THE ONLY WARRANTY GIVEN BY WATTS WITH RESPECT TO THE SYSTEM. WATTS MAKES NO OTHER WARRANTIES, EXPRESS OR IMPLIED. WATTS HEREBY SPECIFICALLY DISCLAIMS ALL OTHER WARRANTIES, EXPRESS OR IMPLIED, INCLUDING THE IMPLIED WARRANTIES OF MERCHANTABILITY OR FITNESS FOR A PARTICULAR PURPOSE. The warranty remedy described above shall constitute the sole and exclusive remedy for breach of warranty, and Watts shall not be responsible for an incidental or consequential damages, including travel expense, telephone charges, loss of revenue or profits, loss of time, inconvenience, loss of use of the equipment, or loss or damage caused by this system and its failure to function properly. This warranty sets forth all of Watts responsibilities regarding this system.

### Your Rights Under State Law:

Some states do not allow the exclusion or limitation of incidental or consequential damages and some states do not allow limitations on how long implied warranties may last. Therefore, the above limitations or exclusions may not apply to you. This warranty gives you specific legal rights and you may also have other rights, which vary from state to state. SO FAR AS IS CONSISTENT WITH APPLICABLE STATE LAW, ANY IMPLIED WARRANTIES THAT MAY NOT BE DISCLAIMED, INCLUDING IMPLIED WARRANTIES OF MERCHANTABILITY OR FITNESS FOR A PARTICULAR PURPOSE ARE LIMITED IN DURATION TO ONE YEAR FROM THE DATE OF ORIGINAL PURCHASE.

