

WiFi Snow Melting Control 670



Table of Contents

Important Safety Information.....	3	Watts® Home App	31
Installation	4	Add Control to App	31
Preparation	4	Using the App	32
Packaging Contents	4	Sequence of Operation	33
Physical Dimensions	4	Snow Melting Overview.....	33
Installation Location.....	4	Melt – Automatic Start and Stop	33
Installing the Enclosure	5	Melt – EconoMelt.....	34
Rough-In Wiring.....	6	Additional Melting Time	34
Sensor Wiring	7	Melt – Automatic Start and Timed Stop	34
tekmarNet	9	Tandem Snow/Ice Detection	35
Manual Melt Input.....	10	Melt – Manual Start and Timed Stop	35
Equipment Wiring	10	Melt - Tracked Start and Stop	35
Testing the Sensor Wiring	13	Idle Operation	36
Testing the Control Wiring	13	Storm Operation	36
Manual Override – Maximum Heat	14	Slab Temperature Control	36
Manual Override – Purge	14	Slab Protection	37
Manual Override – Test	14	Warm Weather Shut Down.....	37
Manual Override – Off.....	14	Cold Weather Cut Off	37
Access Levels.....	14	Snow Melt Zones and Priority	37
User Interface.....	15	Time Clock.....	39
Home Screen.....	15	Away Operation	39
System Operation.....	15	tekmarNet Scene Operation.....	39
Symbols	16	Application Modes	40
Help Screen.....	16	Electric Operation.....	40
Status Menu Navigation	16	Pulse Width Modulation Zone Operation	40
System Status Menu	17	Boiler Operation.....	41
Slab Status Screen.....	18	Mixing Operation	42
Weather Status Screen	18	Boiler and Mixing Operation.....	42
Settings Menu Navigation	19	Outdoor Sensor	42
Temp Menu.....	20	Exercising	42
Away Menu	21	Post Purge	42
Display Menu	21	Troubleshooting.....	43
WiFi Menu.....	22	Error Messages (1 of 4)	43
Time Menu.....	22	Error Messages (2 of 4)	44
Energy Menu	23	Error Messages (3 of 4)	45
Monitor Menu.....	24	Frequently Asked Questions	46
Setup – System Setup Menu.....	25	Technical Data.....	47
Setup – Boiler Setup Menu	26	Limited Warranty and Product Return Procedure	48
Setup – Mixing Setup Menu	27		
tekmarNet Menu	28		
Toolbox Menu	29		
Override Menu	30		

Getting Started

Congratulations on the purchase of your new Snow Melting Control!

This manual covers the complete installation, programming and sequence of operation for this control. You will also find instruction on testing, commissioning, and troubleshooting the control and system that it operates.

Important Safety Information

It is your responsibility to ensure that this control is safely installed according to all applicable codes and standards. tekmar is not responsible for damages resulting from improper installation and/or maintenance.



This is a safety-alert symbol. The safety alert symbol is shown alone or used with a signal word (DANGER, WARNING, or CAUTION), a pictorial and/or a safety message to identify hazards. When you see this symbol alone or with a signal word on your equipment or in this manual, be alert to the potential for death or serious personal injury.



This pictorial alerts you to electricity, electrocution, and shock hazards.



WARNING This symbol identifies hazards which, if not avoided, could result in death or serious injury.



CAUTION This symbol identifies hazards which, if not avoided, could result in minor or moderate injury.

NOTICE

This symbol identifies practices, actions, or failure to act which could result in property damage or damage to the equipment.

WARNING



Read manual and all product labels BEFORE using the equipment. Do not use unless you know the safe and proper operation of this equipment. Keep this manual available for easy access by all users. Replacement manuals are available at tekmarControls.com

WARNING

- It is the installer's responsibility to ensure that this control is safely installed according to all applicable codes and standards.
- Improper installation and operation of this control could result in damage to the equipment and possibly even personal injury or death.
- This control is not intended for use as a primary limit control. Other controls that are intended and certified as safety limits must be placed into the control circuit.

NOTICE

Do not attempt to service the control. There are no user serviceable parts inside the control. Attempting to service the control voids the warranty.

Radio Frequency Interference

The installer must ensure that this control and its wiring are isolated and/or shielded from strong sources of electromagnetic noise. Conversely, this Class B digital apparatus complies with Part 15 of the FCC Rules and meets all requirements of the Canadian Interference-Causing Equipment Regulations. However, if this control does cause harmful interference to radio or television reception, which is determined by turning the control off and on, the user is encouraged to try to correct

the interference by re-orientating or relocating the receiving antenna, relocating the receiver with respect to this control, and/or connecting the control to a different circuit from that to which the receiver is connected.

Cet appareil numérique de la classe B respecte toutes les exigences du Règlement sur le matériel brouilleur du Canada.

Installation

Preparation

Tools Required

- tekmar or jeweler screwdriver
- Phillips head screwdriver
- Needle-nose pliers
- Wire stripper

Materials Required

- 18 AWG LVT solid wire (low-voltage connections)
- 14 AWG solid wire (line-voltage connections)
- Four 1/8" - 1" wood screws

Packaging Contents

The following are included in the product packaging:

- 1 WiFi Snow Melting Control 670
- 3 Universal Sensor 082
- 1 Outdoor Sensor 070
- 1 screwdriver
- 1 Application Brochure 670_A
- 1 Installation and Operation Manual 670_D
- 1 User Manual 670_U

Physical Dimensions

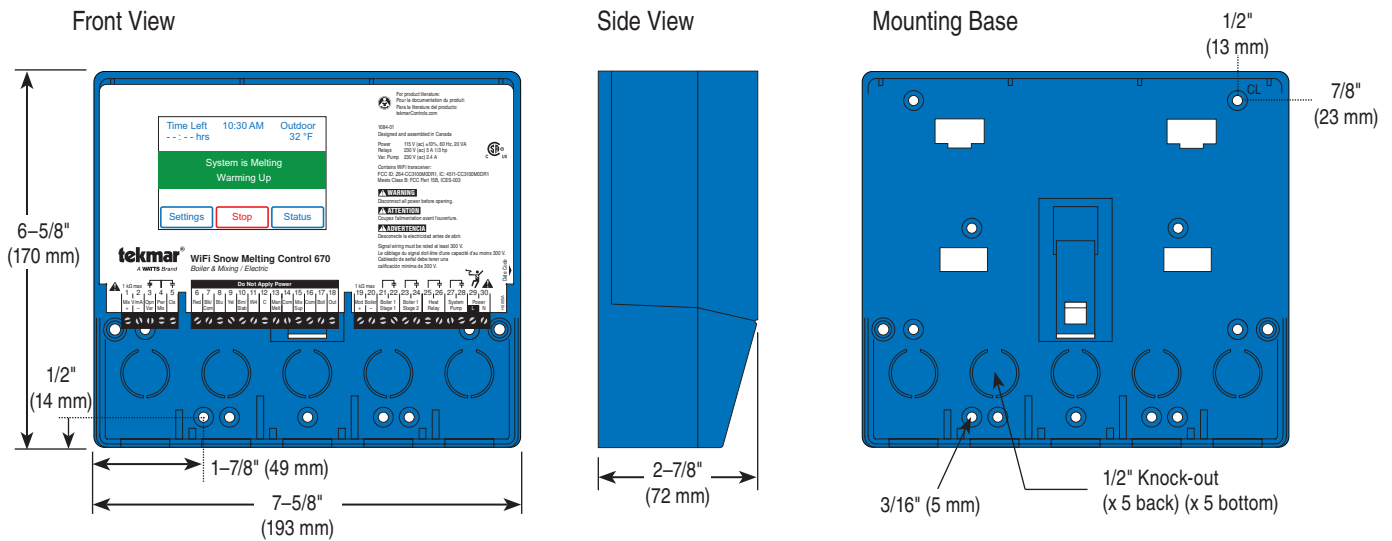

Installation Location

Choose the placement of the control early in the construction process to enable proper wiring during rough-in.

NOTICE

- Keep the control dry. Avoid potential leakage onto the control.
- Maintain relative humidity less than 90% in a non-condensing environment.
- Avoid exposure to extreme temperatures beyond 32-122°F (0-50°C).
- Install away from equipment, appliances, or other sources of electrical interference.
- Install to allow easy access for wiring, viewing, and adjusting the display screen.
- Install approximately 5 feet (1.5 m) off the finished floor.
- Locate the control near pumps and/or zone valves if possible.
- Provide a solid backing which the enclosure can be mounted to. Example: plywood or wall studs.
- Use the conduit knockouts provided on the upper, lower, back and sides of the enclosure for wiring.

Installing the Enclosure

- Install the control enclosure to a wall or to an electrical box.
- Three wiring chamber dividers are included. The dividers provide a barrier to keep low voltage wiring separated from line voltage wiring.
- If the dividers are not used, then low voltage circuits must use wire rated at least 300 V.

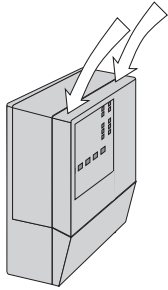

Press down at the fingertip grips on top of the front cover and pull out and down.

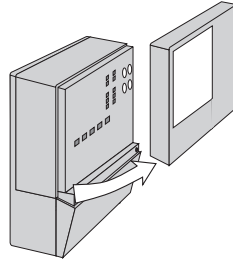

Lift the front cover up and away from the control.

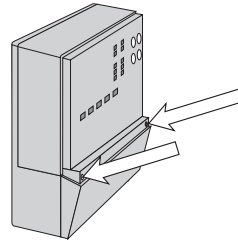

Loosen the screws at the front of the wiring cover.

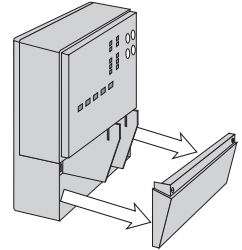

The wiring cover pulls straight out from the wiring chamber.

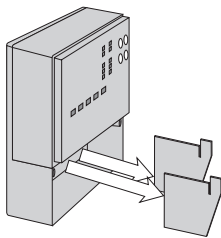

Remove the safety dividers from the wiring chamber by pulling them straight out of their grooves.

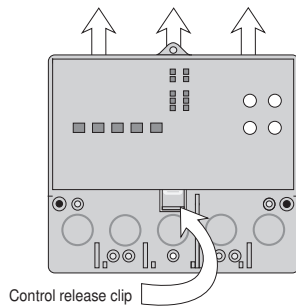

Press the control release clip on the base inside the wiring chamber and slide the control upwards.

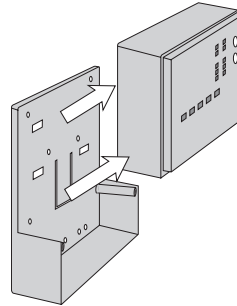

The control lifts up and away from the base.

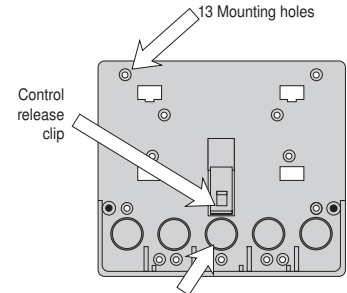

There are 10 conduit knock-outs at the back and bottom of the wiring chamber.

The base is ready for mounting.

The control can be mounted on a standard DIN rail. First remove the control from its base and then, using the hooks and spring clip on the back of the control, mount it onto the DIN rail. This will be a popular option for those who prefer to mount the control inside a larger electrical panel. The DIN Snap Kit M9303 is sold separately.

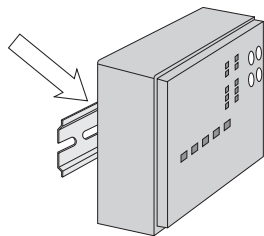

The wiring can enter the bottom or the back of the enclosure. Knock-outs provided in the base allow the wiring to be run in conduit up to the enclosure. The base also has holes that line up with the mounting holes of most common electrical boxes.

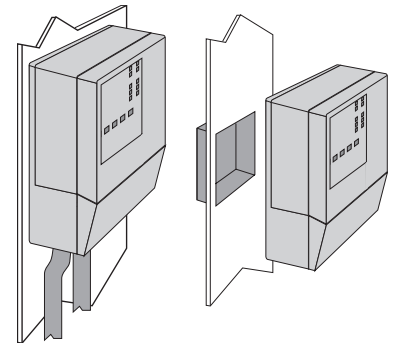

Rough-In Wiring

⚠ WARNING



To prevent the risk of personal injury and/or death, make sure power is not applied to the control until it is fully installed and ready for final testing. All work must be done with power to the circuit being worked on turned off. Please be aware local codes may require this control to be installed or connected by an electrician.

NOTICE

- Install the supplied wiring compartment barriers by sliding them into the grooves provided to isolate the low and line-voltage wiring.
- Strip all wiring to a length of 3/8 in. or 10 mm for all terminals.
- A circuit breaker or power disconnect that provides power to the control should be located nearby and clearly labeled.
- Refer to the current and voltage ratings at the back of this manual before connecting devices to this control.

Low-Voltage Wiring

Pull two conductor 18 AWG LVT cable, up to 500 feet (150 m) long, for the following equipment:

- Outdoor temperature sensor
- Mix supply sensor
- Boiler sensor
- Single-stage on/off boiler
- Modulating boiler 0-10 V (dc) or 4-20 mA
- Mixing valve or mixing injection pump using a 0-10 V (dc) or 4-20 mA signal.

Pull three conductor 18 AWG LVT cable, up to 500 feet (150 m) long, for the following equipment:

- Mixing valves using a floating action signal

Pull four conductor 18 AWG LVT cable, up to 500 feet (150 m) long, for the following equipment:

- Snow Sensor 095
- Two-stage on/off boiler

Pull the Snow/Ice Sensor 090 or 094 cable to the control.

Line-Voltage Wiring

Pull two conductor 14 AWG cable, up to 500 feet (150 m) long, for the following equipment:

- System pump
- Boiler pump
- Heat exchanger on/off injection pump
- Variable speed injection pump

Sensor Wiring

Mounting the Outdoor Sensor

- The temperature sensor (thermistor) is built into the sensor enclosure.
- The outdoor sensor can either be mounted directly onto a wall and the wiring should enter through the back or bottom of the enclosure. Do not mount the outdoor sensor with the conduit knockout facing upwards because rain could enter the enclosure and damage the sensor.
- In order to prevent heat transmitted through the wall from affecting the sensor reading, it may be necessary to install an insulating barrier behind the enclosure.
- The outdoor sensor should be mounted on a north-facing wall. The outdoor sensor should not be exposed to heat sources such as ventilation or window openings.
- The outdoor sensor should be installed at an elevation above the ground that will prevent accidental damage or tampering.

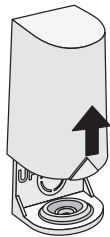

Remove cover by sliding upwards away from the base.

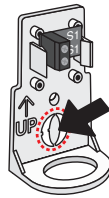

To wire from the back, remove the knock-out in the sensor base.

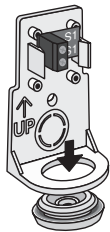

If using conduit, remove the flexible plug from the base bottom.

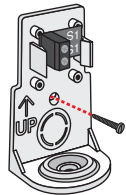

Attach the base to the wall, soffit or electrical box.

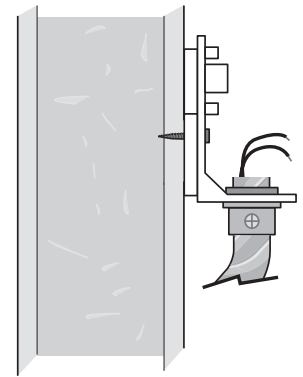
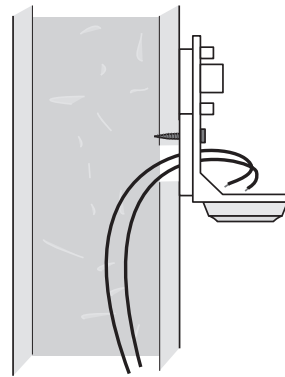

Wiring the Outdoor Sensor

- Connect 18 AWG or similar wire to the two terminals provided in the enclosure and run the wires from the outdoor sensor to the control. Do not run the wires parallel to telephone or power cables. If the sensor wires are located in an area with strong sources of electromagnetic interference (EMI), shielded cable or twisted pair should be used or the wires can be run in a grounded metal conduit. If using shielded cable, the shield wire should be connected to the Com terminal on the control and not to earth ground.
- Follow the sensor testing instructions in this manual and connect the wires to the control.
- Replace the front cover of the sensor enclosure.

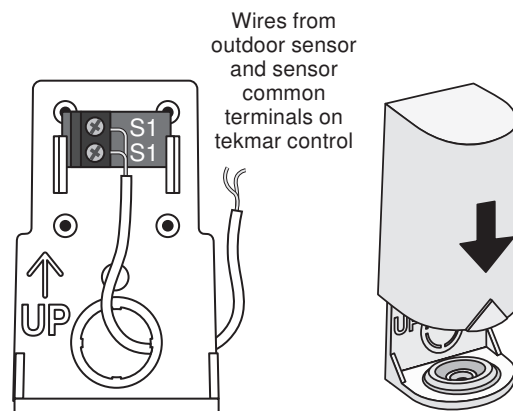

At the control:

- Connect the outdoor sensor to terminals 16 and 18.

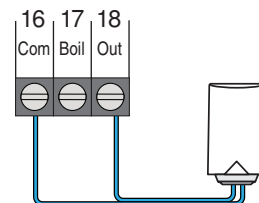

Mounting the Boiler and System Sensors

The Universal Sensor 082 is designed to mount on a pipe or in a temperature immersion well. The sensor should be placed downstream of a pump or after an elbow or similar fitting. This is especially important if large-diameter pipes are used as the thermal stratification within the pipe can result in erroneous sensor readings. Proper sensor location requires that the fluid is thoroughly mixed within the pipe before it reaches the sensor.

Strapped to Pipe

The Universal Sensor can be strapped directly to the pipe using the cable tie provided. Insulation should be placed around the sensor to reduce the effect of air currents on the sensor measurement.

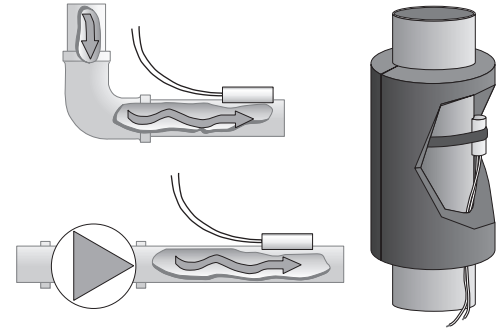

Immersion Well

If a Universal Sensor is mounted onto 1" (25 mm) diameter L type copper pipe, there is approximately an 8 second delay between a sudden change in water temperature and the time the sensor measures the temperature change. This delay increases considerably when mild steel (black iron) pipe is used. In general, it is recommended that a temperature well be used for steel pipe of diameter greater than 1-1/4" (32 mm). Temperature wells are also recommended when large diameter pipes are used and fluid stratification is present.

Conduit Connection

The Universal Sensor and Universal Sensor Enclosure 080 (sold separately) are specifically designed to mount onto a 3/8" (10 mm) ID temperature well that is supplied with an end groove. To install the well, plumb a tee into the pipe and fix the well into the tee. The 080 enclosure has a 7/8" (22 mm) back knockout that must be removed and fitted over the temperature well. The universal sensor is then inserted into the well and the retaining clip supplied with the enclosure is snapped onto the well end groove. If the well has a threaded end, the installer must supply a standard threaded conduit retaining ring. The two wires from the sensor are connected to the terminal block provided in the enclosure. The other side of the terminal block is used to connect wires from the control.

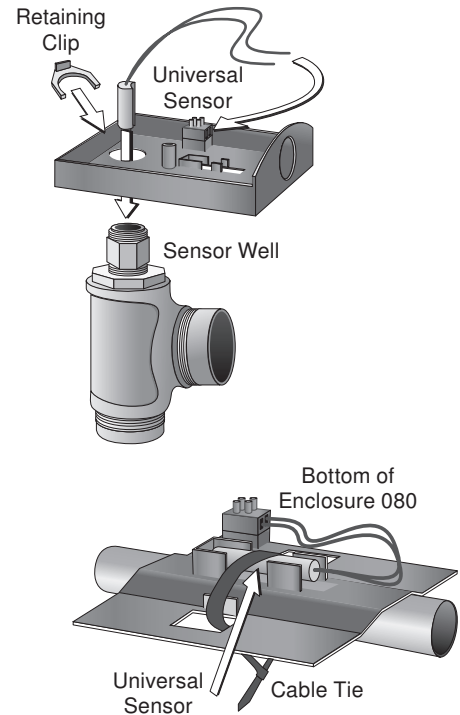

Mounting the Boiler Sensor

The boiler sensor is used when operating a boiler.

- If applicable, connect the boiler sensor to terminals 16 and 17.

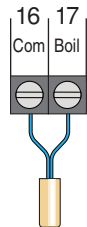

Mounting the Mix Supply Sensor

The mix supply sensor is used when operating a mixing valve or a variable speed injection pump is installed.

- If applicable, connect the mix supply sensor to terminals 14 and 15.

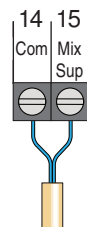

Snow/Ice Sensor

A Snow/Ice Sensor 090 or 094 can be connected to the control. The 090 has a 65' (20 m) cable and the 094 has a 208' (63 m) cable. The cable may be extended to a total length of 500' (150 m) using 18 AWG cable. Any junction boxes must be kept dry.

If the Snow/Ice Sensor input is used:

- Connect the red wire to terminal 6.
- Connect the black wire to terminal 7.
- Connect the blue wire to terminal 8.
- Connect the yellow wire to terminal 9.
- Connect the brown wire to terminal 10.

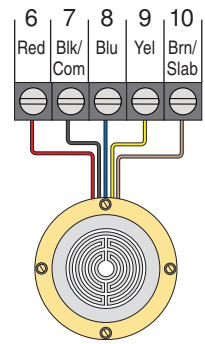

Snow Sensor

A Snow Sensor 095 can be connected to the control.

If the Snow Sensor input is used:

- Connect the red wire to terminal 6.
- Connect the black wire to terminal 7.
- Connect the blue wire to terminal 8.
- Connect the yellow wire to terminal 9.

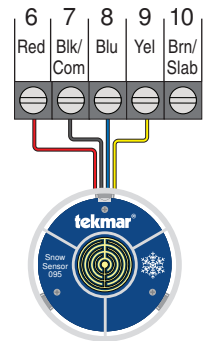

Slab Sensor

A Slab Sensor 072 or 073 can be installed either alone or together with a Snow Sensor 095.

If the Slab Sensor input is used:

Connect the slab sensor to terminals 7 and 10.

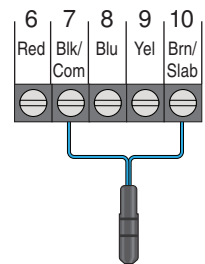

tekmarNet

The 670 can be connected to other tekmarNet communication compatible controls using the tN4 bus.

If tekmarNet is used:

- Connect tN4 on the 670 terminal 11 to the tN4 wiring terminal on the other device.
- Connect C on the 670 terminal 12 to the C wiring terminal on the other device.
- tekmarNet is polarity sensitive.

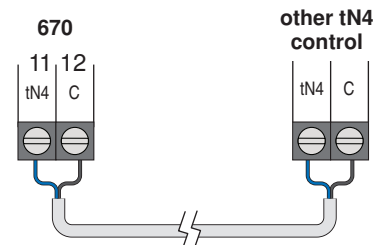

Manual Melt Input

The manual melt input allows the control to be manually switched to melting operation using a switch. This connection is optional.

If the Manual Melt input is used:

Connect a switch to terminals 13 and 14. The switch may be either dry (no voltage) or a voltage signal up to 32 V (ac).

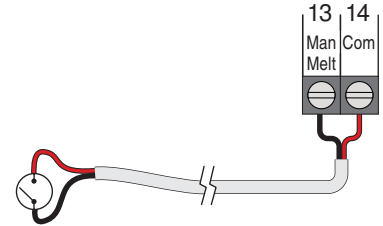

Equipment Wiring

Wiring the Analog Mixing Output

The control can operate a mixing valve by providing a 0-10 V (dc) or a 4-20 mA signal to the valve actuating motor.

- If applicable, connect the mixing actuator positive (+) to terminal 1.
- If applicable, connect the mixing actuator negative (-) to terminal 2.

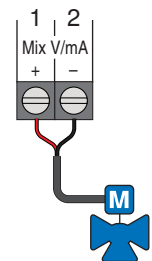

Wiring the Floating Action Mixing Output

The control provides a floating action signal to operate a floating action actuator. The floating action mixing output uses dry relay contacts that can switch either 24, 120, or 230 V (ac). When using 24 V (ac), a Transformer 009 is required to power the actuator. The actuator terminals are typically labeled for clockwise and counterclockwise rotation. The control's open and close terminals are wired to the actuator depending on the direction the valve rotates to open and close respectively.

- Connect the power source to the Pwr terminal 4 on the control.
- Connect the Opn terminal 3 to the actuator terminal that rotates the valve open.
- Connect the Cls terminal 5 to the actuator terminal that rotates the valve close.
- If using a 24 V (ac) transformer, connect the actuator common to the transformer C.
- If using a 120 V or 230 V (ac) power supply, connect the actuator common to the power supply neutral (N).

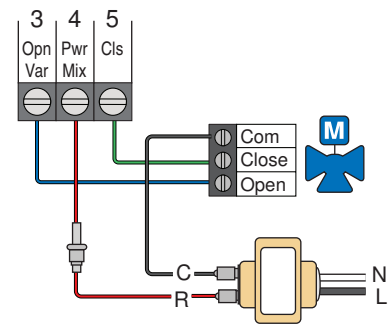

Wiring the Injection Mixing Pump

A variable speed injection mixing pump requiring up to 230 V (ac), 2.4 A is operated through terminals 3 and 4. For simplicity in wiring and troubleshooting, a separate breaker for the pump is recommended.

- Connect 115 or 230 V (ac) power L to the Pwr Mix terminal 4.
- Connect a wire from Var terminal 3 to the pump L.
- Connect a wire from the pump N to the power Neutral.
- Connect the ground wire (G) to the pump.

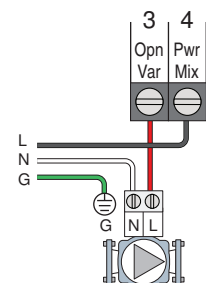

Wiring to a Modulating Boiler

The control provides either a 4-20 mA or a 0-10 V (dc) output to the boiler. Polarity must be observed.

- Connect the Mod + terminal from the boiler to terminal 19.
- Connect the Mod - terminal from the boiler to terminal 20.
- Some modulating boilers require an enable to start firing the boiler. Connect the boiler enable to the stage 1 terminals 21 and 22.

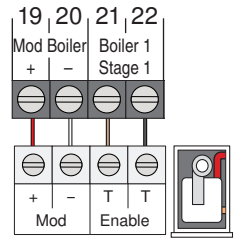

The 4 to 20 mA output can be converted to a 0 - 135 Ω output for a Modutrol IV™ gas valve actuating motor using a 0 - 135 Ω tekmar Converter 005 (sold separately).

The 4 to 20 mA output can be converted to a 0 - 135 Ω output for a V9055™ gas valve actuating motor using a 0 - 135 Ω tekmar Converter 005 (sold separately).

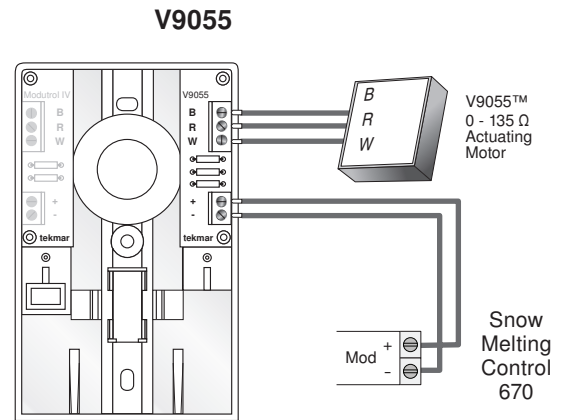
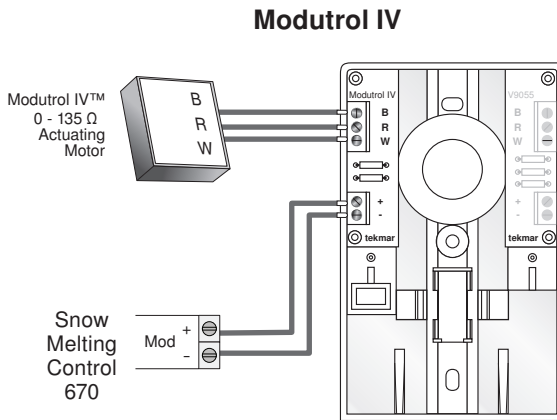

Modutrol IV™ and V9055™ are trademarks of Honeywell, Inc.

Wiring to a Single-Stage Boiler

A single-stage boiler is enabled through the T-T contacts.

- Connect Stage 1 terminals 21 and 22 to the boiler T-T contacts.

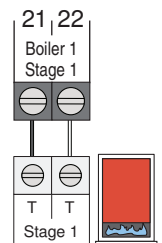

Wiring to a Two-Stage Boiler

A two-stage boiler is enabled through the T-T contacts.

- Connect Stage 1 terminals 21 and 22 to the boiler's stage 1 contacts.
- Connect Stage 2 terminals 23 and 24 to the boiler's stage 2 contacts.

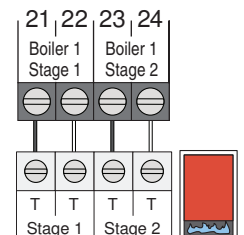

Wiring the Heat Relay

If the heat relay is operating a pump:

The pump can be rated up to 230 V (ac), 5 A, 1/3 hp and switched through terminals 25 and 26. For simplicity in wiring and troubleshooting, a separate breaker for each pump is recommended.

- Connect the power source line wire (L) to terminal 26.
- Connect a wire from terminal 25 to the pump L.
- Connect a wire from the pump N back to the power source neutral.
- Connect the ground wire (G) to the pump.

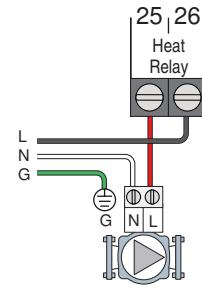

If the heat relay is wired to a 24 V(ac) on-off valve:

- Connect the power source red wire (R) to terminal 25.
- Connect a wire from terminal 26 to the valve R.
- Connect a wire from the valve C to the power source common.

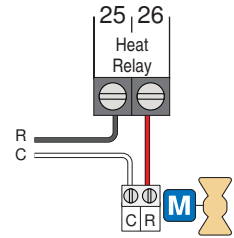

If the heat relay is wired to an electrical contactor:

- Connect a wire from terminal 25 to the electrical contactor R.
- Connect a wire from terminal 26 to the electrical contactor C.

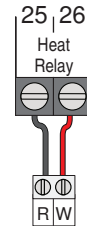

Wiring the System Pump

A system pump requiring up to 230 V (ac), 5 A, 1/3 hp can be switched through terminals 27 and 28. For simplicity in wiring and troubleshooting, a separate breaker for each pump is recommended.

- Connect the power source line wire (L) to terminal 28.
- Connect a wire from terminal 27 to the pump L.
- Connect a wire from the pump N back to the power source neutral.
- Connect the ground wire (G) to the pump.

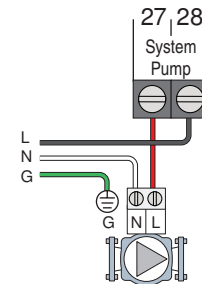

Wiring the Input Power

Provide a 15 A circuit for the input power.

- Connect the 115 V (ac) line wire (L) to terminal 29.
- Connect the neutral wire (N) to terminal 30.

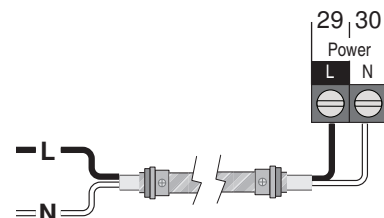

Testing the Sensor Wiring

A good quality test meter capable of measuring up to 5,000 k Ω (1 k Ω = 1000 Ω) is required to measure the sensor resistance. In addition, the actual temperature must be measured with either a high-quality digital thermometer, or if a thermometer is not available, a second sensor can be placed alongside the one to be tested and the readings compared.

First, measure the temperature using the thermometer and then measure the resistance of the sensor at the control. The wires from the sensor must not be connected to the control while the test is performed. Using the chart below, estimate

the temperature measured by the sensor. The sensor and thermometer readings should be close. If the test meter reads a very high resistance, there may be a broken wire, a poor wiring connection or a defective sensor. If the resistance is very low, the wiring may be shorted, there may be moisture in the sensor or the sensor may be defective. To test for a defective sensor, measure the resistance directly at the sensor location.

Do not apply voltage to a sensor at any time as damage to the sensor may result.

Temperature		Resistance	Temperature		Resistance	Temperature		Resistance	Temperature		Resistance
$^{\circ}\text{F}$	$^{\circ}\text{C}$	Ω	$^{\circ}\text{F}$	$^{\circ}\text{C}$	Ω	$^{\circ}\text{F}$	$^{\circ}\text{C}$	Ω	$^{\circ}\text{F}$	$^{\circ}\text{C}$	Ω
-50	-46	490,813	20	-7	46,218	90	32	7,334	160	71	1,689
-45	-43	405,710	25	-4	39,913	95	35	6,532	165	74	1,538
-40	-40	336,606	30	-1	34,558	100	38	5,828	170	77	1,403
-35	-37	280,279	35	2	29,996	105	41	5,210	175	79	1,281
-30	-34	234,196	40	4	26,099	110	43	4,665	180	82	1,172
-25	-32	196,358	45	7	22,763	115	46	4,184	185	85	1,073
-20	-29	165,180	50	10	19,900	120	49	3,760	190	88	983
-15	-26	139,403	55	13	17,436	125	52	3,383	195	91	903
-10	-23	118,018	60	16	15,311	130	54	3,050	200	93	829
-5	-21	100,221	65	18	13,474	135	57	2,754	205	96	763
0	-18	85,362	70	21	11,883	140	60	2,490	210	99	703
5	-15	72,918	75	24	10,501	145	63	2,255	215	102	648
10	-12	62,465	80	27	9,299	150	66	2,045	220	104	598
15	-9	53,658	85	29	8,250	155	68	1,857	225	107	553

Testing the Control Wiring

Remove the front cover from the control.

Testing the Power

- Use an electrical meter set to measure (ac) voltage.
- Measure between the L and N terminals.
- The reading should be 115 V (ac) +/- 10%.

Hand Manual Override

The control includes a Hand Manual Override menu to check if the control's relays are operating and that the control is wired correctly to the snow melting equipment.

Step 1: Press Settings button.

Step 2: Press Override button.

Step 3: Press Manual Override.

Step 4: Select Manual Override to Hand.

Step 5: Press Back button.

Step 6: The following outputs can be operated:

- System Pump relay
- Heat Relay
- Boiler Stage 1 relay
- Boiler Stage 2 relay
- Boiler Modulation 0-10 V (dc) or 4-20 mA signal
- Mix System Output 0-10 V (dc) or 4-20 mA signal
- Mix System Output floating action relays
- Mix System Output variable-speed injection pump

For each relay output

- Use an electrical meter set to measure (ac) voltage.
- Measure between the relay wiring terminals.
- When the relay is off, the voltage should be 115 V (ac).
- When the relay is on, the voltage should be 0 V (ac).

For the Boiler Modulation

- Use an electrical meter set to measure V (dc) or mA.
- Set the Boiler Modulation to 100%.
- The voltage between the + and – wiring terminals should be 10 V (dc) or 20 mA.
- Set the Boiler Modulation to 0%.
- The voltage between the + and – wiring terminals should be 0 V (dc) or 4 mA.

For the Mix System Output – Floating Action

- Use an electrical meter set to measure (ac) voltage.
- Set the Mix Output to 100%. The floating action open wiring terminal will be closed for the length of the motor speed setting (default is 105 seconds).
- When opening, the voltage between the open and common wiring terminals should be 24 V (ac) or 115 V (ac).
- When opening, the voltage between the close and common wiring terminals should be 0 V (ac).
- Set the Mix Output to 0%. The floating action closed wiring terminal will be closed for the length of the motor speed setting (default is 105 seconds).
- When closing, the voltage between the open and common wiring terminals should be 0 V (ac).
- When closing, the voltage between the close and common wiring terminals should be 24 V (ac) or 115 V (ac).

For the Mix Output – Analog Mixing

- Use an electrical meter set to measure V (dc) or mA.
- Set the Mix Output to 100%.
- The voltage between the + and – wiring terminals should be 10 V (dc) or 20 mA.
- Set the Mix Output to 0%.
- The voltage between the + and – wiring terminals should be 0 V (dc) or 4 mA.

For the Mix Output – Variable Speed Injection Mixing

- Use an electrical meter set to measure V (ac).
- Set the Mix Output to 100%.

- The voltage between the Var and N wiring terminals should be 115 V (ac).
- Set the Mix Output to 0%.
- The voltage between the Var and N wiring terminals should be 0 V (ac).

Exiting the Hand Manual Override

- Exit the Manual Override by selecting Auto.
- Install the front cover.

Manual Override – Maximum Heat

In hydronic application modes, the control includes a Maximum Heat operation where the control operates the snow melting system to maintain the maximum allowed heating setpoints. This allows testing of the snow melting system during warm weather.

- Step 1: Press Settings button.
- Step 2: Press Override button.
- Step 3: Press Manual Override.
- Step 4: Select Manual Override to Max Heat.
- Step 5: Press Back button. The control starts the Max Heat operation.
- Step 6: Exit the Manual Override by selecting Auto.

Manual Override – Purge

When operating a hydronic snow melting system, it is necessary to purge and bleed all air out of the system. The control includes a Purge operation where the system, primary and boiler pumps are all turned on to assist in purging air from the system.

- Step 1: Press Settings button.
- Step 2: Press Override button.
- Step 3: Press Manual Override.
- Step 4: Select Manual Override to Purge.
- Step 5: Press Back button. The control starts the Purge operation.
- Step 6: Exit the Manual Override by selecting Auto.

Manual Override – Test

When operating an electric snow melting system, the control includes a Test operation where the electrical heating cables can be energized for 10 minutes, after which the control resumes normal operation. This allows testing of the electric snow melting system during warm weather.

- Step 1: Press Settings button.
- Step 2: Press Override button.
- Step 3: Press Manual Override.
- Step 4: Select Manual Override to Test.
- Step 5: Press Back button. The control starts the electric test operation for up to 10 minutes before exiting automatically.
- Step 6: Exit the Manual Override by selecting Auto.

Manual Override – Off

The snow melting system can be manually turned off and the control remains off until manually changed back to Auto. This allows the installer or end user to permanently disable the snow melting system without removing power from the control.

- Step 1: Press Settings button.
- Step 2: Press Override button.
- Step 3: Press Manual Override.
- Step 4: Select Manual Override to Off.
- Step 5: Press Back button. The control is now in the off manual override.
- Step 6: Exit the Manual Override by selecting Auto.

Access Levels

The control is shipped pre-programmed with common settings. The control has an “Installer” access level that allows full access to all settings and a “User” access level that restricts the number of settings available. The control defaults to the “User” access level after 12 hours of operation.

To change to the “Installer” access level:

- Step 1: Press the Settings button.
- Step 2: Press the Toolbox button.
- Step 3: Press Access Level.
- Step 4: Press the Installer radio button.

User Interface

Home Screen

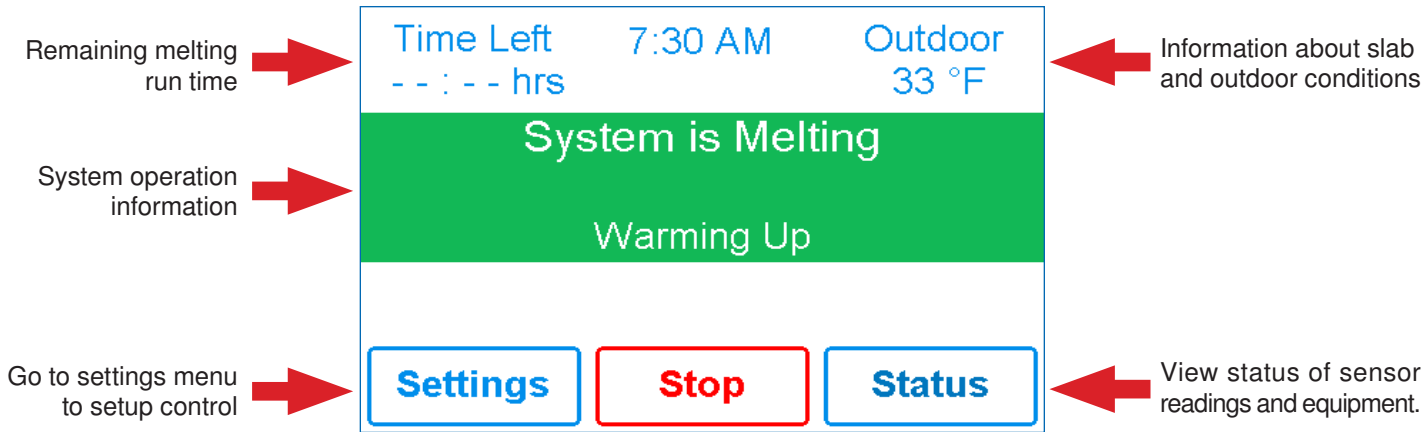

System Operation

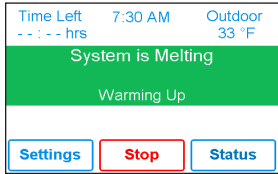

SYSTEM IS MELTING

- The control has either detected snow/ice and automatically started or the control was manually started.
- "Warming Up" is shown when the slab is below the slab target temperature.

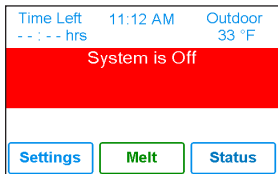

SYSTEM IS OFF

- The snow melting system is off and is ready to detect snow or ice.
- "Warm Weather Shut Down" is shown when the slab and outdoor temperature are above the WWSD setting. During WWSD, the snow will melt naturally due to warm outdoor temperatures.
- "Cold Weather Shut Down" is shown when the outdoor temperature is below the CWCO setpoint. The outdoor temperature is so cold the heating system does not have capacity to melt snow.
- "Melt Pending" is shown when the system is off during CWCO but will resume melting once the outdoor temperature increases above the CWCO setpoint.

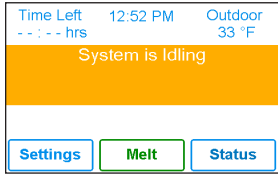

SYSTEM IS IDLING

- The control is pre-heating the slab to the idling setpoint. This reduces the amount of time needed to reach the melting setpoint in the event snow or ice is detected.

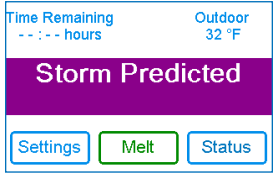

STORM PREDICTED

- The Internet weather forecast is predicting a snow fall and the control is pre-heating the slab to the storm setpoint. This reduces the amount of time needed to reach the melting setpoint in the event snow or ice is detected.



SYSTEM IN OVERRIDE / SYSTEM IN EXERCISING

- The control is in a manual override for testing, commissioning or exercising.
- The description field explains which type of override is active.

Symbols



WARNING SYMBOL

The control has an error message. Press the warning symbol to determine the error code and information on how to take corrective action. Refer to the Troubleshooting section for a list of error codes.

Help Screen

The display includes a Help screen for each setting. The Help screen provides a description of the setting that is identical to the description found in the Installation and Operation Manual.

Temperatures	
Melting Setpoint	36 °F
Idling Setpoint	Off
Storm Setpoint	Off
Manual Melt Time	04:00 hr
Add Melt Time	00:00 hr

Buttons: Back, Up, Down, Help

Melting Setpoint

Select the desired temperature of the snow melt surface when melting.

Buttons: Back, Up, Down

Status Menu Navigation

Step 1: Press the Status button on the Home Screen.

Step 2: Press either the System, Slab or Weather button.

Step 3: Press up or down buttons to scroll through the list.

Status

System Slab Weather

Back Help

System

Slab

Weather

System Status	
Manual Melt Input	Off
Boiler Target	142 °F
Boiler Supply	143 °F
Boiler Output	0 %
Stage 1	Off

Buttons: Back, Up, Down, Help

Slab Status	
Outdoor	33 °F
Slab Target	- - - °F
Slab Sensor	36 °F
Sensor Water Status	Dry
Wifi rssi	-21

Buttons: Back, Up, Down, Help

Weather Status



Current weather: Sunny Cloudy
Current Outdoor: 61 °F

Snow Forecast: 0.0 in

Buttons: Back

System Status Menu

Description	Range	Access
<p>MANUAL MELT INPUT When Manual Melt wiring terminal 13 is shorted to common wiring terminal 14, the control is enabled and enters the melting operation unless prevented by warm weather shut down or cold weather cut out. When the manual melt input is disconnected, the control completes the melting cycle and then returns to off, idle or storm operation. Conditions: Always</p>	Off, Enabled	User Installer
<p>TEKMARNET When tekmarNet communication is present, the status shows active. When there is no tekmarNet communication, the status is off. Conditions: Always</p>	Off, Active	User Installer
<p>BOILER TARGET The boiler target calculated by the control based on outdoor temperature, slab temperature and the melting, idling, or storm setpoints. "--" is displayed when no heat is required. Conditions: Application mode is set to Boiler or Boiler+Mix.</p>	---, 50 to 230°F (10.0 to 110.0°C)	User Installer
<p>BOILER SUPPLY Current boiler supply water temperature. Conditions: Application mode is set to Boiler or Boiler+Mix.</p>	-31 to 266°F (-35.0 to 130.0°C)	Installer
<p>BOILER OUTPUT Current boiler plant percent output. Conditions: Application mode is set to Boiler or Boiler+Mix.</p>	0 to 100%	User Installer
<p>STAGE 1 Current status of the stage 1 relay. Conditions: Application mode is set to PWM Zone, Mixing, Boiler, or Boiler+Mix.</p>	On or Off	User Installer
<p>STAGE 2 Current status of the stage 2 relay. Conditions: Boiler type is set to Stage 2.</p>	On or Off	User Installer
<p>MIX TARGET The mix target calculated by the control based on outdoor temperature, slab temperature and one of either the melting, idling, or storm setpoints. "--" is displayed when no heat is required. Conditions: Application mode is set to Mixing or Boiler+Mix.</p>	---, 70 to 200°F (21.0 to 93.5°C)	User Installer
<p>MIX SUPPLY Current mix supply water temperature. Conditions: Application mode is not set to Electric.</p>	-31 to 266°F (-35.0 to 130.0°C)	User Installer
<p>MIX OUTPUT Current position of the mixing valve or output of the variable speed injection pump. Conditions: Application mode is set to Mixing or Boiler+Mix.</p>	0 to 100%	User Installer
<p>SYSTEM PUMP Current status of the system loop pump. Conditions: Application mode is set to PWM Zone, Mixing, Boiler or Boiler+Mix.</p>	On or Off	User Installer
<p>HEAT RELAY Current status of the heat relay. Conditions: Application mode is set to Electric, PWM Zone, Mixing.</p>	On or Off	User Installer
<p>ELECTRIC ENABLE RELAY Current status of the electric snow melt enable relay. Conditions: Application mode is set to Electric.</p>	On or Off	User Installer

Slab Status Screen

Description	Range	Access
OUTDOOR Current outdoor air temperature as measured by the outdoor sensor or from the tekmarNet system or Internet weather forecast. “---” is displayed when no outdoor temperature reading is available. Conditions: Always available.	---, -67 to 149°F (-55.0 to 65.0°C)	User Installer
SLAB TARGET The slab target calculated by the control based on outdoor temperature and the melting, idling, or storm setpoints. “- -” is displayed when no heat is required. Conditions: Always available.	---, 32 to 110°F (0 to 43.0°C)	Installer
SLAB SENSOR Current slab sensor temperature. Conditions: Snow/ice sensor set to In-slab or slab sensor is set to On.	-58 to 167°F (-50.0 to 75.0°C)	User Installer
SENSOR WATER STATUS Current status of snow/ice sensor moisture detector. Conditions: Snow/ice sensor is set to In-slab or Aerial.	DRY or WET	User Installer

Weather Status Screen

When WiFi is turned on, the control receives weather data from the Internet. The current weather, outdoor temperature and forecast snow fall information is displayed.

The screenshot shows a screen titled "Weather Status" with a blue header. Below the header is a weather icon of a sun partially covered by a cloud. The text on the screen reads: "Current weather: Sunny Cloudy", "Current Outdoor: 61 °F", and "Snow Forecast: 0.0 in". At the bottom is a "Back" button. Callout lines point from the text "Current outdoor conditions" to the weather icon, and from "Predicted snow forecast" to the "Snow Forecast: 0.0 in" text.

Settings Menu Navigation

Step 1: Press the Settings button on the Home Screen.

Step 2: Press one of the ten buttons.

Step 3: Press up or down buttons to scroll through the list.

Step 4: Press the highlighted setting name to change the setting value.

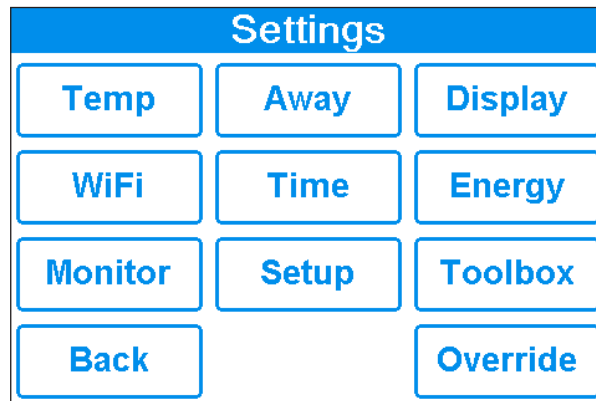

Temp

Temperatures	
Melting Setpoint	36 °F
Idling Setpoint	Off
Storm Setpoint	Off
Manual Melt Time	04:00 hr
Add Melt Time	00:00 hr
<input type="button" value="Back"/> <input type="button" value="▲"/> <input type="button" value="▼"/> <input type="button" value="Help"/>	

Away

Away	
<input checked="" type="radio"/> At Home <input type="radio"/> Away	
<input type="button" value="Back"/> <input type="button" value="Help"/>	

Display

Display	
Temperature Units	°F
Screen Brightness	75 %
<input type="button" value="Back"/> <input type="button" value="▲"/> <input type="button" value="▼"/> <input type="button" value="Help"/>	

WiFi

WiFi	
WiFi	On
Network SSID	
Postal/Zip	V1B3K4
Time Source	Auto
<input type="button" value="Back"/> <input type="button" value="▲"/> <input type="button" value="▼"/> <input type="button" value="Help"/>	

Time

Time	
Time Source	Auto
Time Format	12 hr
Time Zone	Eastern
Daylight Savings	On
<input type="button" value="Back"/> <input type="button" value="▲"/> <input type="button" value="▼"/> <input type="button" value="Help"/>	

Energy

Daily Usage	
Thu	1 hrs
Wed	0 hrs
Tue	0 hrs
Mon	0 hrs
Sun	0 hrs
Sat	0 hrs
Fri	0 hrs
<input type="button" value="Back"/> <input type="button" value="Monthly Usage"/> <input type="button" value="Help"/>	

Monitor

Monitor	
Melting Hours	0:56 hr
Heat Hours	0:40 hr
Heat Cycles	0
System Pump	0:59 hr
Slab Sensor High	36 °F
<input type="button" value="Back"/> <input type="button" value="▲"/> <input type="button" value="▼"/> <input type="button" value="Help"/>	

Toolbox

Toolbox	
Error Code	15
Access Level	Installer
Type 670	J1254 A
Load Defaults	No
Calibrate Touchscreen	
<input type="button" value="Back"/> <input type="button" value="▲"/> <input type="button" value="▼"/> <input type="button" value="Help"/>	

Override

Override	
Manual Override	Auto
<input type="button" value="Back"/> <input type="button" value="▲"/> <input type="button" value="▼"/> <input type="button" value="Help"/>	

Temp Menu		
Description	Range	Access
<p>MELTING SETPOINT Select the desired temperature of the snow melt surface when melting. Conditions: Always available.</p>	32 to 95°F (0.0 to 35.0°C) Default = 36°F (2.0°C)	User Installer
<p>IDLING SETPOINT Select the desired temperature of the snow melt surface when idling. Idling preheats the slab when the slab is dry but cold and allows faster reaction time to reach the melting temperature when snow is detected. Recommended for commercial use only. Conditions: Always available.</p>	OFF, 20 to 95°F (-6.5 to 35.0°C) Default = Off	User Installer
<p>STORM SETPOINT Select the desired temperature of the snow melt surface while operating in the storm operation. Storm operation temporarily preheats the slab to allow faster reaction time to reach the melting temperature when snow is detected. Storm operation is automatically activated by the Internet weather forecast or manually started by a User Switch or Gateway. Conditions: Always available.</p>	OFF, 20 to 95°F (-6.5 to 35.0°C) Default = Off	User Installer
<p>MANUAL MELT TIME Select the amount of running time when manually starting the system. Conditions: Always available.</p>	0:30 to 24:00 hours Default = 4:00 hours	User Installer
<p>ADD MELT TIME Select the amount of additional melting time after the Snow/Ice Sensor is dry. This allows low spots on the slab to fully dry before the snow melting system is shut off. Conditions: Snow/ice sensor is set to In-slab.</p>	0:00 to 6:00 hours Default = 0:00 hours	Installer
<p>STORM RUN TIME Select the amount of storm run time to pre-heat the slab when advised of a winter storm warning. Conditions: Storm setpoint is set to a temperature.</p>	0:30 to 24:00 hours Default = 8:00 hours	Installer
<p>SENSITIVITY Select how sensitive Snow/Ice Sensor is to water detection. Conditions: Snow/ice sensor is set to In-slab or Aerial.</p>	Auto, Min, -2, -1, Mid, +1, +2, Max Default = Auto	Installer
<p>WWSD Select the temperature above which the snow melting system is shut off during warm weather. This allows the snow or ice to melt off the slab naturally. Conditions: Always available.</p>	Auto, 32 to 95°F (0.0 to 35.0°C) Default = Auto	Installer
<p>CWCO Select the temperature below which the snow melting system is shut off during extremely cold weather. Below this temperature, the heat loss of the slab exceeds the capacity of the boiler or heating appliance. Conditions: Always available.</p>	Off, -30 to 50°F (-34.5 to 10.0°C) Default = 10°F (-12.0°C)	Installer

Away Menu

At Home

Select at home to allow automatic snow melting operation.

Away

Select away to prevent snow melting operation and save energy.

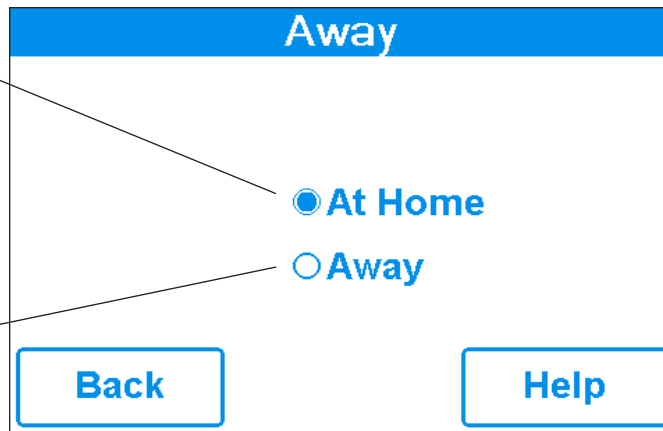

NOTICE

The home/away changes devices system-wide. All thermostats and controls that are grouped together as a location on the tekmar Connect mobile app will change together. All thermostats and controls on a tekmarNet system will also change together.

Display Menu

Description	Range	Access
TEMPERATURE UNITS Select Fahrenheit or Celsius temperature units. Conditions: Always available.	°F or °C	User Installer
SCREEN BRIGHTNESS Select the screen brightness. Conditions: Always available.	0 to 100% Default = 75%	User Installer
CLEAN SCREEN The Clean Screen timer locks the screen for 10 seconds allowing the user to wipe the screen with a moist cloth. Do not use solvents to clean the screen. Conditions: Always available.	N/A	User Installer

WiFi Menu

NOTICE

Before using the WiFi features of this product, you must accept the Terms of Use, as amended from time to time and available at Watts.com/terms-of-use. If you do not accept these terms, this product can still be used without WiFi features.

Description	Range	Access
WiFi Enable or disable WiFi connectivity. The help screen displays the following information: <ul style="list-style-type: none"> • IP Address • Subnet Mask • Gateway IP • MAC Address Conditions: Always available.	Off or On	User Installer
NETWORK SSID Select the WiFi network from the list. Conditions: WiFi is set to On.	List of WiFi Networks	User Installer
ZIP/POSTAL CODE Enter a US ZIP or Canadian postal code. The ZIP/Postal Code is used to provide the location for the weather information. The weather service is available in the USA and Canada only. Conditions: WiFi is set to On.	US ZIP format 12345 Canada Postal Code format A1B2C3	User Installer
TIME SOURCE Select to set to the time automatically or manually. Conditions: WiFi is set to On.	Auto, Manual	User Installer

Time Menu

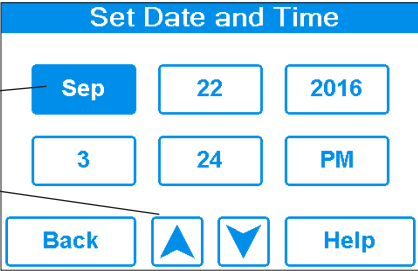
Description	Range	Access
TIME SOURCE Select to set to the time automatically or manually. Auto is only available when WiFi is set to On. Conditions: Always available.	Auto, Manual	User Installer
SET TIME AND DATE Conditions: Always available. <ul style="list-style-type: none"> • Press box field. • Then adjust with arrow buttons. 	N/A	User Installer
TIME FORMAT Select either 12 or 24 hour format. Conditions: Always available.	12 hr, 24 hr Default = 12 hr	User Installer
TIME ZONE Select the location's time zone. Conditions: Available when Time Source is set to Manual.	Hawaii, Alaska, Pacific, Mountain, Central, Eastern, Atlantic, NFLD, (Newfoundland)	User Installer
DAYLIGHT SAVINGS Set Daylight Savings to On to automatically adjust for time changes in the spring and fall. Conditions: Always available.	Off or On Default = On	User Installer

Energy Menu

View the snow melting system running hours in the past week.

Daily Usage	
Thu	1 hrs
Wed	0 hrs
Tue	0 hrs
Mon	0 hrs
Sun	0 hrs
Sat	0 hrs
Fri	0 hrs

[Back](#) [Monthly Usage](#) [Help](#)

View the snow melting system running hours in the past year.

Monthly Usage		
Sep	1 hrs	Mar 0 hrs
Aug	0 hrs	Feb 0 hrs
Jul	0 hrs	Jan 0 hrs
Jun	0 hrs	Dec 0 hrs
May	0 hrs	Nov 0 hrs
Apr	0 hrs	Oct 0 hrs

[Back](#) [Daily Usage](#) [Help](#)

Monitor Menu		
Description	Range	Access
MELTING ENERGY Records the amount of energy since the counter was last reset. Conditions: Available when Application Mode is set to Electric.	0 to 999999 kWh	User Installer
MELTING HOURS Records the number of melting hours since the counter was last reset. Conditions: Always available.	0 to 999999 hours	User Installer
HEAT HOURS Records the number of hours the boiler fired or the electric cable heated since the counter was last reset. Conditions: Available when Application Mode is Boiler, Boiler+Mix and Electric.	0 to 999999 hours	User Installer
HEAT CYCLES Records the number of cycles the boiler turned on or the electric cable heated since the counter was last reset. Conditions: Available when Application Mode is Boiler, Boiler+Mix and Electric.	0 to 999999 cycles	Installer
SYSTEM PUMP Records the number of hours the system pump has operated since the counter was last reset. Conditions: Available when Application Mode is not set to Electric.	0 to 999999 hours	Installer
SLAB SENSOR HIGH Records the highest measured slab temperature since the counter was last reset. Conditions: Available when Snow/Ice Sensor is set to In-slab or Slab Sensor = On.	-58 to 167°F (-50.0 to 75.0°C)	Installer
SLAB SENSOR LOW Records the lowest measured slab temperature since the counter was last reset. Conditions: Available when Snow/Ice Sensor is set to In-slab or Slab Sensor = On.	-58 to 167°F (-50.0 to 75.0°C)	Installer
OUTDOOR HIGH Records the highest measured outdoor air temperature since the counter was last reset. Conditions: Always available.	-67 to 149°F (-55.0 to 65.0°C)	Installer
OUTDOOR LOW Records the lowest measured outdoor air temperature since the counter was last reset. Conditions: Always available.	-67 to 149°F (-55.0 to 65.0°C)	Installer
BOILER HIGH Records the highest measured boiler temperature since the counter was last reset. Conditions: Available when Application Mode is set to Boiler or Boiler+Mix.	-31 to 266°F (-35.0 to 130.0°C)	Installer
BOILER LOW Records the lowest measured boiler temperature since the counter was last reset. Conditions: Available when Application Mode is set to Boiler or Boiler+Mix.	-31 to 266°F (-35.0 to 130.0°C)	Installer
MIX SUPPLY HIGH Records the highest measured mix temperature since the counter was last reset. Conditions: Available when Application Mode is set to PWM Zone, Mixing or Boiler+Mix.	-31 to 266°F (-35.0 to 130.0°C)	Installer
MIX SUPPLY LOW Records the lowest measured mix temperature since the counter was last reset. Conditions: Available when Application Mode is set to PWM Zone, Mixing or Boiler+Mix.	-31 to 266°F (-35.0 to 130.0°C)	Installer
RESET ALL? Resets all the counters in the monitor menu at once. Conditions: Always available.	N/A	Installer

Setup

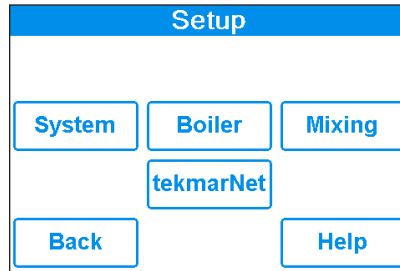

Setup – System Setup Menu

Description	Range	Access
<p>APPLICATION MODE The Application Mode selects the operation of the mechanical equipment. Application Mode “PWM Zone” operates a pump or zone valve to provide heat to the snow melting system.</p> <p>Application Mode “Mixing” operates a mixing valve or a variable speed injection mixing pump to heat the snow melting system. The heat source is enabled.</p> <p>Application Mode “Boiler” operates a modulating, 1-stage or 2-stage boiler to heat the snow melting system.</p> <p>Application Mode “Boiler+Mix” operates a mixing valve or a variable speed injection mixing pump and controls the boiler temperature to heat the snow melting system.</p> <p>Application Mode “Electric” uses electric cables to heat the snow melting system. Conditions: Always available.</p>	PWM Zone Mixing Boiler Boiler+Mix Electric Default = Boiler+Mix	Installer
<p>SNOW/ICE SENSOR Select if a Snow/Ice Sensor 090 or 094 "Inslab", or a Snow Sensor 095 "Aerial" is installed. Conditions: Always available.</p>	None, In-slab, Aerial Default = In-slab	Installer
<p>SLAB SENSOR Select if a Slab Sensor 072 or 073 is installed. Conditions: Available when snow/ice sensor is set to None or Aerial.</p>	Off or On Default = Off	Installer
<p>SLAB PROTECTION Select if a concrete slab should be protected from large temperature differentials to avoid cracking the concrete due to high tensile stress. This limits the heat-up rate of the concrete slab. Slab protection is not required for installations with brick pavers, asphalt or other non-concrete materials. Conditions: Available when 1) Application mode is set to Mixing, Boiler or Boiler+Mix, 2) Snow/ice sensor is set to Inslab or slab sensor is set to On.</p>	Off or On Default = On	Installer
<p>ECONOMELT EconoMelt allows the user to mechanically remove snow then manually start the system to melt the remaining thin snow layer or ice with an automatic stop when the sensor is dry. Conditions: Available when snow/ice sensor is set to In-slab.</p>	Off or On Default = Off	Installer
<p>MAX MELT DAYS Limit the amount of melting run time after snow is automatically detected by a Snow/Ice Sensor 090 or 094, or a Snow Sensor 095. Conditions: Always available.</p>	Off, 0.5 to 7 days Default = 3 days	Installer
<p>OUTDOOR SENSOR Select if the outdoor air temperature is measured by the control, by a tekmarNet system or by the Internet weather service. Conditions: Always available.</p>	Control, tekmarNet, Internet Default = Control	Installer

Setup – Boiler Setup Menu

Description	Range	Access
<p>BOILER TYPE Select the type of boiler operated by the control. Mod = Modulating boiler with an adjustable firing rate using a 0-10V (dc) or 4-20 mA signal. 1 Stage = Single one-stage on/off boiler. 2 Stage = Single two-stage on/off boiler. EMS = Modulating boiler with an adjustable target temperature using a 0-10V (dc) or 4-20 mA signal. Enable = Enable for Application Mode PWM Zone or Mix. Control = Call for heat to tekmarNet control. Conditions: Always available.</p>	Mod, 1 Stage, 2 Stage, EMS, Enable, Control Default = Mod	Installer
<p>BOILER MODULATION TYPE Select between a 0-10 V (dc) or 4-20 mA signal to control the modulating boiler. Conditions: Available when 1) Application Mode is set to Boiler or Boiler+Mix, and 2) Boiler Type is set to Mod or EMS.</p>	0-10 V or 4-20 mA Default: 0-10 V	Installer
<p>BOILER MIN MODULATION Set the boiler minimum modulation of the boiler burner. Conditions: Available when 1) Application Mode is set to Boiler or Boiler+Mix, and 2) Boiler Type is set to Mod.</p>	0 to 50% Default = 0%	Installer
<p>BOILER MODULATION DELAY Set the time the boiler operates at the minimum firing rate before allowing the firing rate to change. This allows the boiler ignition system to establish a flame. Conditions: Available when 1) Application Mode is set to Boiler or Boiler+Mix, and 2) Boiler Type is set to Mod.</p>	Off, 10 to 180 seconds Default = Off	Installer
<p>BOILER MOTOR SPEED Set the time required for the modulating burner actuating motor to fully open the gas valve or ramp the burner fan speed from off to full speed. Set to 30 seconds unless otherwise recommended by the boiler manufacturer. Conditions: Available when 1) Application Mode is set to Boiler or Boiler+Mix, and 2) Boiler Type is set to Mod.</p>	30 to 230 seconds Default = 30	Installer
<p>BOILER DIFFERENTIAL The temperature differential that the control uses to cycle the boiler on and off. The differential is split evenly half above and half below of the boiler target. Conditions: Available when Application Mode is set to Boiler or Boiler+Mix.</p>	Auto, 2 to 42°F (1.0 to 23.5°C) Default = Auto	Installer
<p>BOILER MINIMUM When Application Mode is set to Mixing or Boiler+Mix: The boiler return minimum protects both condensing and non-condensing boilers from cold return water temperatures. The mixing valve is closed or the variable speed injection mixing is reduced when the boiler return temperature falls below this setting. When Application Mode is set to Boiler: The minimum allowed boiler target temperature. Check the boiler manufacturer's manual for recommended return water temperatures.</p>	Off, 50 to 180°F (10.0 to 82.0°C) Default = Off	Installer
<p>EMS SIGNAL MINIMUM The starting voltage for the EMS boiler signal. This voltage corresponds to the EMS Low Temperature setting. Check the boiler manufacturer's manual for the starting voltage for the EMS signal range. Conditions: Available when 1) Boiler Type is set to EMS, and 2) Boiler Modulation Type is set to 0-10 V.</p>	0.5 to 10 Vdc Default = 0.5 Vdc	Installer
<p>EMS LOW TEMPERATURE The EMS boiler target temperature that corresponds to the EMS Signal Minimum voltage or 4 mA. Check the boiler manufacturer's manual for the minimum EMS target temperature. Conditions: Available when Boiler Type is set to EMS.</p>	50 to 210°F (10 to 99.0°C) Default = 50°F (10.0°C)	Installer
<p>EMS HIGH TEMPERATURE The EMS boiler target temperature that corresponds to 10 V (dc) or 20 mA. Check the boiler manufacturer's manual for the maximum EMS target temperature. Conditions: Available when Boiler Type is set to EMS.</p>	50 to 210°F (10.0 to 99.0°C) Default = 210°F (99.0°C)	Installer

Setup – Mixing Setup Menu

Description	Range	Access
<p>MIXING TYPE Select the mixing output type. Floating = Floating action mixing output to operate a mixing valve. Injection = Injection mixing output to operate a wet-rotor, impedance protected pump with a current less than 2.4 A. 0-10 V = Analog mixing output provides a 0-10 V (dc) signal. 4-20 mA = Analog mixing output provides a 4-20 mA signal. Conditions: Available when Application Mode is set to Mixing or Boiler+Mix.</p>	<p>Floating, Injection, 0-10 V, 4-20 mA Default = Floating</p>	<p>Installer</p>
<p>MIX MOTOR SPEED Set the time that the mixing actuating motor requires to operate from fully closed to fully open. Check the mixing actuator motor instruction manual for the motor speed time. Conditions: Available when 1) Application Mode is set to Mixing or Boiler+Mix, and 2) Mixing Type is set to Floating, 0-10 V, or 4-20 mA.</p>	<p>30 to 230 seconds Default = 105 seconds</p>	<p>Installer</p>
<p>MIX MAXIMUM Set the maximum operating temperature of the system supply water temperature. Conditions: Available when Application Mode is set to Mixing or Boiler+Mix.</p>	<p>80 to 180 °F, Off (26.5 to 82.5 °C) Default = 140 °F (60.0 °C)</p>	<p>Installer</p>

tekmarNet Menu

Description	Range	Access
<p>ADDRESSING The tekmarNet address of this control. Select between automatic and manual addressing. To manually set the address, use the up or down buttons. Conditions: Available when the 670 is connected to other controls using tekmarNet communication.</p>	<p>Auto, b:01 to b:24, 1:01 to 1:24, 2:01 to 2:24, 3:01 to 3:24</p>	<p>Installer</p>
<p>DEVICE COUNT Provides a count of all the tekmarNet thermostats, setpoint controls and snow melting controls on a tN4 bus. Conditions: Available when the 670 is connected to other controls using tekmarNet communication.</p>	<p>1 to 24</p>	<p>Installer</p>
<p>SNOW MELT ZONE Select the snow melting zone that this control operates. Snow zone 1 has the highest priority while snow zone 12 has the lowest priority. Conditions: Available when the 670 is connected to other controls using tekmarNet communication.</p>	<p>1 to 12</p>	<p>Installer</p>
<p>TRACK ZONE Select to track and record the running hours of snow zone 1 and repeat this run time on this control. This allows snow melting zones without a snow/ice sensor to automatically start. Conditions: Available when 1) The 670 is connected to other controls using tekmarNet communication and 2) Snow zone is set to 2 through 12.</p>	<p>Off or On</p>	<p>Installer</p>
<p>MELT GROUP A User Switch or Gateway may be used to manually start melting the zone. Set the Melt Group number to the corresponding Setpoint Enable number on the User Switch or Gateway. Conditions: Available when the 670 is connected to other controls using tekmarNet communication.</p>	<p>1 to 12</p>	<p>Installer</p>
<p>STORM GROUP A User Switch or Gateway may be used to manually start the storm operation for the zone. Set the Storm Group number to the corresponding Setpoint Enable number on the User Switch or Gateway. Conditions: Available when the 670 is connected to other controls using tekmarNet communication.</p>	<p>1 to 12</p>	<p>Installer</p>
<p>PRIORITY Select the priority of the snow melting system. Conditions: Available when 1) The 670 is connected to other controls using tekmarNet communication and 2) Application Mode is set to PWM Mode, Mix or Electric.</p>	<p>Off, Conditional, Full Default = Off</p>	<p>Installer</p>
<p>AWAY SCENE Select if the control should accept or ignore the away command from the mobile app or from a tekmarNet system. Conditions: Always available.</p>	<p>Off or On Default = On</p>	<p>Installer</p>
<p>TN4 SYSTEM PUMP Select if the system pump located on the tekmarNet System Control should operate when the snow melt zone is heating. Conditions: Available when the 670 is connected to other controls using tekmarNet communication.</p>	<p>Off or On</p>	<p>Installer</p>

Toolbox Menu

Description	Range	Access
<p>ERROR CODE The current error code is displayed. Conditions: Always available.</p>	See Error Code Section	User Installer
<p>ACCESS LEVEL Select the access level of the control. This determines which menus and items are available through the user interface. Conditions: Always available.</p>	User or Installer Default = Installer	User Installer
<p>TYPE 670 Product information. SW: J1254 or J1265 SVN: XXX Conditions: Always available.</p>	Last letter indicates software version	User Installer
<p>LOAD DEFAULTS Select "Yes" to reload the factory defaults on the control. Conditions: Always available.</p>	No or Yes	User Installer
<p>CALIBRATE TOUCHSCREEN A sequence of steps to calibrate the touchscreen. Conditions: Always available.</p>	N/A	User Installer

Override Menu

Description	Range	Access
<p>MANUAL OVERRIDE Manually override the normal automatic operation of the control to test the equipment or operate the system at the maximum temperature limits. Auto = Normal operation. Hand = Manual override of each relay output. Max Heat = Operate hydronic system at maximum heat. Test = Operate electric system for 10 minutes. Purge = Hydronic system purge operates pumps to help bleed air from the system. Conditions: Always available.</p>	Auto, Hand, Max Heat, Test, Purge, Off	User Installer
<p>SYSTEM PUMP Manually turn on the system pump during the HAND Manual Override. Conditions: Available when 1) Application Mode is set to PWM Zone, Boiler, Mixing or Boiler+Mix, and 2) Manual Override is set to Hand.</p>	Off or On Default = Off	User Installer
<p>HEAT RELAY Manually turn on the heat relay during the HAND Manual Override. Conditions: Available when 1) Application Mode is set to PWM Zone, Mix or Electric and 2) Manual Override is set to Hand.</p>	Off or On	User Installer
<p>BOILER ENABLE Manually turn on the boiler during the HAND Manual Override. Conditions: Available when 1) Application Mode is set to PWM Zone or Mix and 2) Manual Override is set to Hand.</p>	Off or On Default = Off	User Installer
<p>BOILER MODULATION Manually set the modulating boiler firing rate during the HAND Manual Override. Conditions: Available when 1) Application Mode is set to Boiler or Boiler+Mix, 2) Manual Override is set to Hand, and 3) Boiler Type is set to Mod.</p>	0 to 100% Default = 0%	User Installer
<p>BOILER STAGE 1 Manually turn on the boiler stage 1 during the HAND Manual Override. Conditions: Available when 1) Application Mode is set to Boiler, Boiler+Mix and 2) Manual Override is set to Hand.</p>	Off or On Default = Off	User Installer
<p>BOILER STAGE 2 Manually turn on the boiler stage 2 during the HAND Manual Override. Conditions: Available when 1) Application Mode is set to Boiler or Boiler+Mix, 2) Manual Override is set to Hand, and 3) Boiler Type is set to Stage 2.</p>	Off or On Default = Off	User Installer
<p>BOILER EMS Manually set the modulating boiler firing rate during the HAND Manual Override. Conditions: Available when 1) Application Mode is set to Boiler or Boiler+Mix, 2) Manual Override is set to Hand, and 3) Boiler Type is set to EMS.</p>	Off, 50 to 210°F (10 to 99.0°C) Default = Off	User Installer
<p>MIX OUTPUT Manually set the mixing valve or injection mixing pump output during the HAND Manual Override. Conditions: Available when 1) Application Mode is set to Mixing or Boiler+Mix, and 2) Manual Override is set to Hand.</p>	0 to 100% Default = 0%	User Installer
<p>HAND DURATION Select the amount of time that the HAND Override is in effect before returning to Automatic operation. Conditions: Available when Manual Override is set to Hand.</p>	0:10 to 72:00 hours Default = 0:10 hour	User Installer
<p>MAX HEAT DURATION Select the amount of time that Max Heat is in effect before returning to Automatic operation. Conditions: Available when 1) Application Mode is set to PWM Zone, Boiler, Mixing or Boiler+Mix, and 2) Manual Override is set to Max Heat.</p>	0:10 to 72:00 hours Default = 24:00 hour	User Installer
<p>PURGE DURATION Select the amount of time that the Purge is in effect before returning to Automatic operation. Conditions: Available when 1) Application Mode is set to PWM Zone, Boiler, Mixing or Boiler+Mix, and 2) Manual Override is set to Purge.</p>	0:10 to 72:00 hours Default = 24:00 hour	User Installer

Watts® Home App

To view and adjust the WiFi Snow Melting Control 670 using a mobile phone or tablet, download the Watts Home mobile app from the Apple® iTunes® Store or from the Google Play® Store.

NOTICE

Before using the WiFi features of this product, you must accept the Terms of Use, as amended from time to time and available at Watts.com/terms-of-use. If you do not accept these terms, this product can still be used without WiFi features.

This product requires WiFi WPA2 security. WiFi networks with security disabled or that use WEP are not supported.

Add Control to App



Step 1

Create a new account. Then sign in using your username and password.

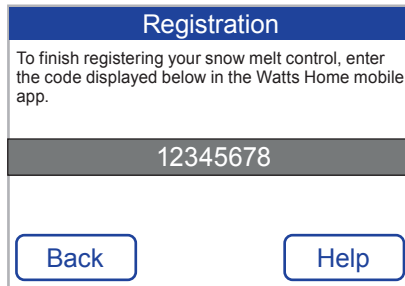

Step 2

On the control, go to the WiFi menu and press Register Device.

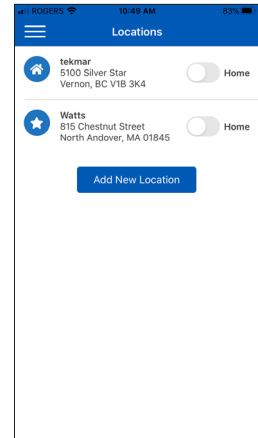

Step 3

Swipe left (Apple) or long hold (Android) to edit the Location name.

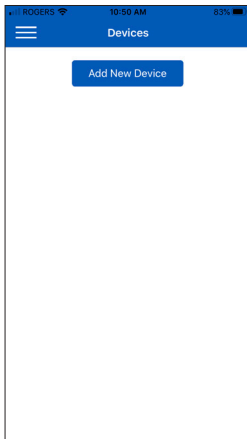

Step 4

Press the Location name and Add New Device.

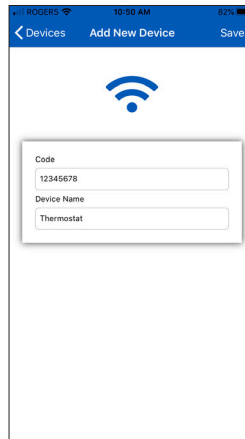

Step 5

Enter the 8 digit code from the control into the mobile app. Then enter the control's device name.

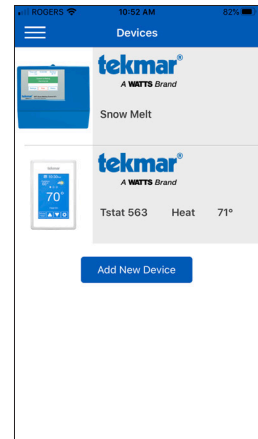

The control is now listed on the Devices page.

Using the App

Settings

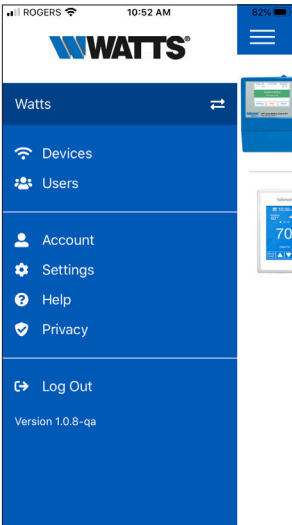

Press ☰ for settings

Locations

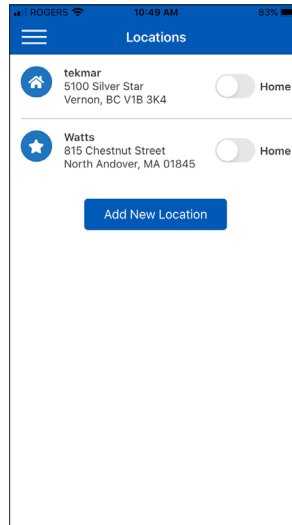

Toggle to **Away** to save energy when you are away for a day or more

Swipe left or long hold to edit or remove location

Devices

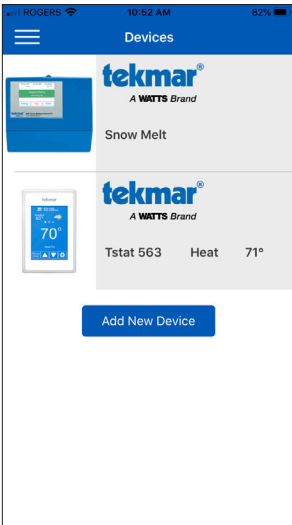

Swipe left or long hold to edit or remove device

Control

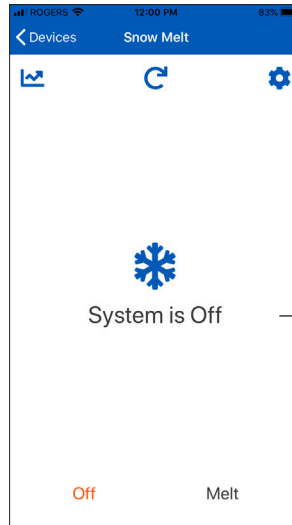

Current system operation status

Select between Off and Melt operation

- Energy use
- Refresh
- Control settings

Sequence of Operation

Snow Melting Overview

A snow melting system can offer a safe, convenient, and cost effective way of removing snow and ice from the snow melting slab and similar surfaces. Safety is increased by activating the snow melting system as soon as the snow falls rather than waiting for mechanical snow removal after snow has accumulated. This eliminates slip hazards and reduces the risk of injury by mechanized snow melting equipment, thereby reducing potential liability costs. The elimination of snow plow equipment and corrosive salts also reduces damage to the slab surface and to the environment. When controlled correctly, snow melting systems can be cost competitive compared to mechanical snow removal.

The snow melting control can operate in one of four different ways:

- Melt** Heats the slab to melt snow or ice. Default is 36°F (2°C)
- Idle** Preheats the slab just below freezing to shorten the time required to melt snow. Default is off.

Storm Temporarily preheats the slab just below freezing to shorten the time required to melt snow. Default is off.

Off Snow melting system is off
The display shows the control operation in the home screen.

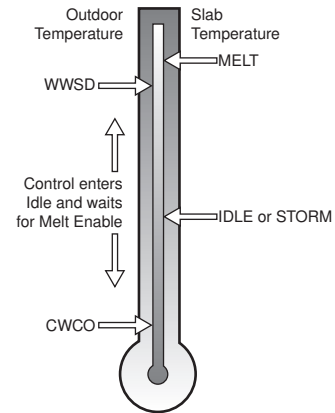

Melt – Automatic Start and Stop

Automatic start and stop operation requires the installation of a Snow/Ice Sensor 090 (65' or 20 m cable) or 094 (208' or 63 m cable). The sensor is installed in-slab level with the melting surface. The control continually monitors the sensor for the presence of moisture and slab temperature conditions in which snow or ice may be present. When moisture is detected, the control shows "Sensor Water Status – Wet" in the Slab Status menu. When the sensor is dry the control shows "Sensor Water Status – Dry". The control includes a Sensitivity setting in the Temperatures menu that allows the installer to adjust the amount of moisture required to start and stop the melting operation. In areas with low amounts of dust and/or air pollution, the sensitivity may need to be increased. The default sensitivity setting is Auto. This setting allows the control to automatically determine the best suitable sensitivity

setting for the installation.

When moisture is detected and the slab and outdoor temperatures are at or below freezing, the control will automatically start the snow melting system. As the snow or ice melts and the slab dries off, the sensor also dries off at the same time. When the sensor is dry, the snow melt system automatically shuts off. If there are low spots on the slab surface that dry off slower than the sensor, additional melting run time can be included by adjusting the Additional Melt Time setting in the Temperatures menu.

If the snow melting system is manually stopped, the snow/ice sensor must fully dry before it is able to detect a new snow fall and automatically start the snow melting system.



Snow/Ice Sensor 090 or 094

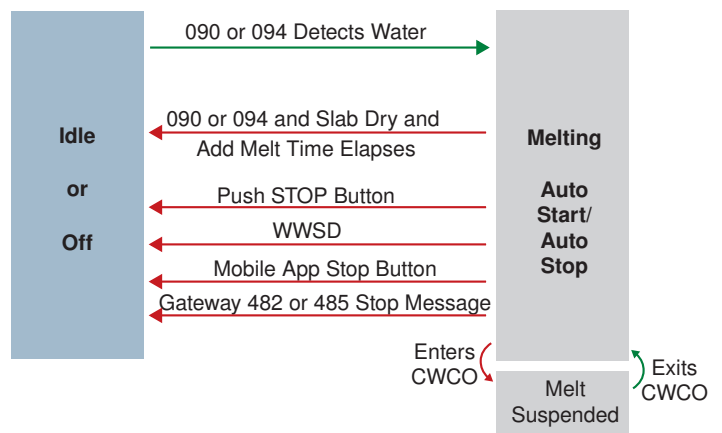

NOTICE

The slab temperature must reach the slab target in order for the system to shut off automatically. The capacity of the heat source must be sized to ensure melting as low as the cold weather cut off. In addition, the heat source maximum temperature setting

must be set to provide the full capacity of the heating appliance. For example, boiler aquastats should be set to 180°F (82°C). Failure to meet these requirements may result in the snow melting system not automatically shutting off when the slab is dry.

Melt – EconoMelt

When a Snow/Ice Sensor 090 or 094 is installed, the installer can choose to select to either automatically or manually start the snow melting system. Selecting EconoMelt to On allows snow removal using a snow plow or shovel. The remaining thin layer of snow or ice that mechanical snow removal methods are unable to remove can be melted using the manual start operation. The snow melting system stops when the sensor is dry. The factory default for EconoMelt is Off.

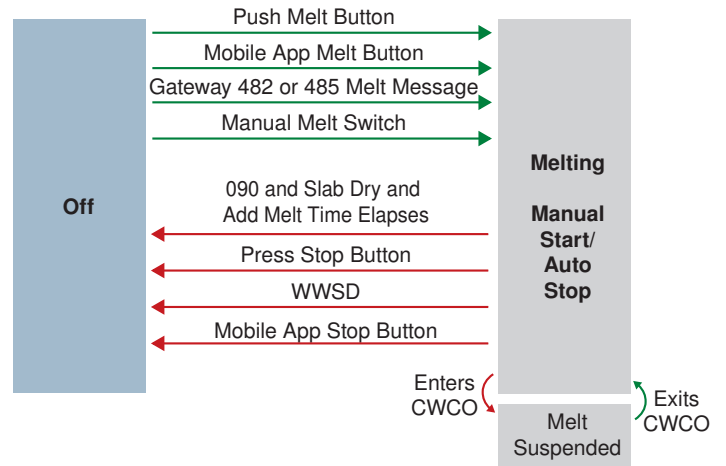

Additional Melting Time

A Snow/Ice Sensor 090 or 094 automatically shuts off the snow melting system when the water sensor is dry. Due to the construction of the slab and the layout of the heating pipe or electrical cable, there may be areas that do not melt completely. The Additional Melt Time setting in the Temperatures menu allows the installer to set addition melting time after the sensor is dry.

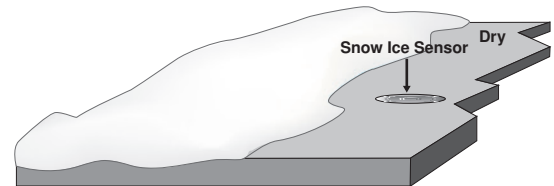

Melt – Automatic Start and Timed Stop

Automatic start with a timed stop operation requires the installation of a Snow Sensor 095. The sensor is aerial mounted on a pole near the melting surface. It is highly recommended to also install a Slab Sensor 072 (20' or 6 m cable) or 073 (40' or 12 m cable) in order to regulate the slab temperature and operate the snow melting system at the highest possible efficiency. The control continually monitors the snow sensor for the presence of moisture and slab temperature conditions in which snow or ice may be present. When moisture is detected, the control will show "Sensor Water Status Wet" in the Slab Status menu. When the sensor is dry the control will show "Sensor Water Status Dry". The control includes a Sensitivity setting in the Temperatures menu that allows the installer to adjust the amount of moisture required to start and

stop the melting operation. In areas with low amounts of dust and/or air pollution, the sensitivity may need to be increased. The default sensitivity setting is Auto. This setting allows the control to automatically determine the best suitable sensitivity setting for the installation.

When moisture is detected and both the slab and outdoor temperatures are below the Melting setting, the control automatically starts the snow melting system. The snow melting system operates to heat the slab to the slab target temperature and continues to operate until the time set by the Manual Melt Run Time in the Temperatures menu elapses. If the 095 re-detects water, the timer is restarted to operate for the full run time.

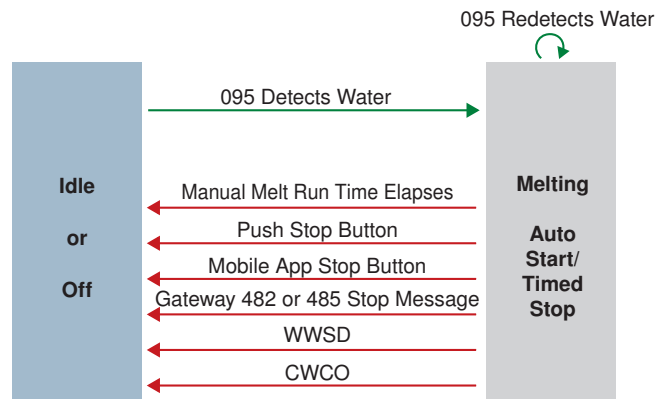

Tandem Snow/Ice Detection

The 670 can be paired together with a 654 to allow two Snow/Ice sensors 090 or 094 or Snow Sensors 095 to be installed for a single zone. This provides full redundancy and increases the snow detection area.

Both sensors are used to detect snow or ice and if either sensor is wet the snow melting zone starts melting. The control continues to operate until both sensors are dry. This allows snow or ice detection over a wider area. In the event of a sensor failure, the control continues to operate normally, giving building maintenance staff time to troubleshoot and replace the faulty sensor if necessary.

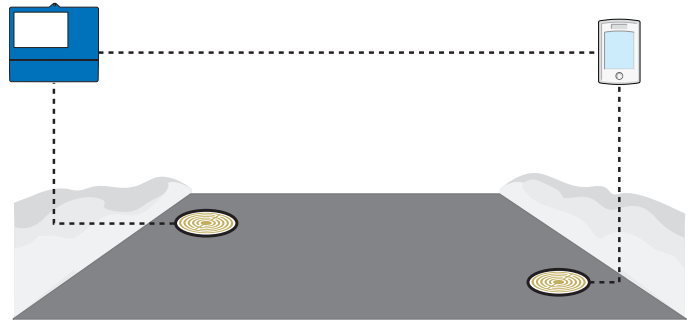

Melt – Manual Start and Timed Stop

The snow melting system can be started manually in one of four different methods:

- Touch the Melt button on the control display
- Through the mobile app
- Through a Gateway 482 or 485 melt request message
- By manually connecting the Manual Melt and Com wiring terminals 13 and 14 together.

Once manually started and the slab warms up to the slab target, the snow melting system runs until the time set by the Manual Melt Run Time setting in the Temperatures menu elapses.

If a manual start has been provided and a Snow/Ice Sensor detects water, the control changes from manual melt to automatic operation. The snow melting system runs until the sensor is dry and the Additional Melt Time elapses.

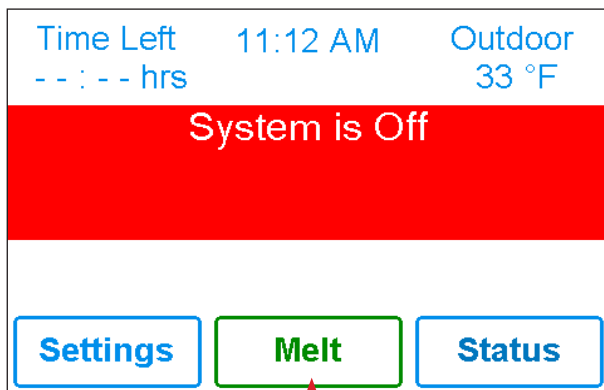

Press Melt button to start melting operation

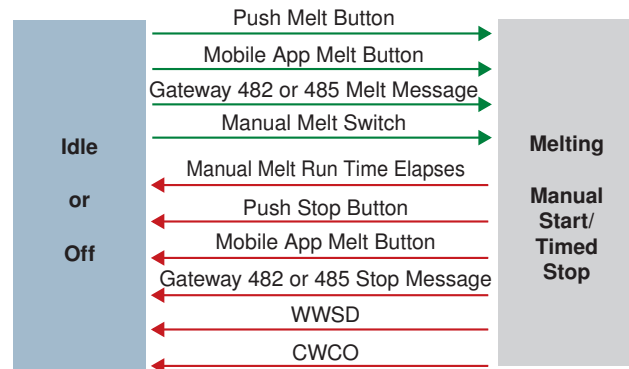

Melt - Tracked Start and Stop

The snow melting system can have multiple zones. Zones have the option to track the melting run time of zone 1. This is useful in cases where zone 1 has an automatic Snow / Ice Sensor installed and the remaining zones do not. This allows zones 2 to 12 to gain the functionality of automatic starting and stopping with only one Snow / Ice sensor installed in the system. When zone 1 detects snow or ice, it starts melting. Zones with tracking enabled can also start melting unless priority is selected. When the sensor in zone 1 is dry or the Manual Melt Run Time has fully elapsed, it sends a signal to the tracked zones that zone 1 has stopped. Each zone can continue to operate to complete their own Additional Melt Time after which the zone stops heating and returns to the Off or Idle operation. Zones with priority selected start after zone 1 has finished melting and repeat the same run time as zone 1.

Track Melt Start and Stop

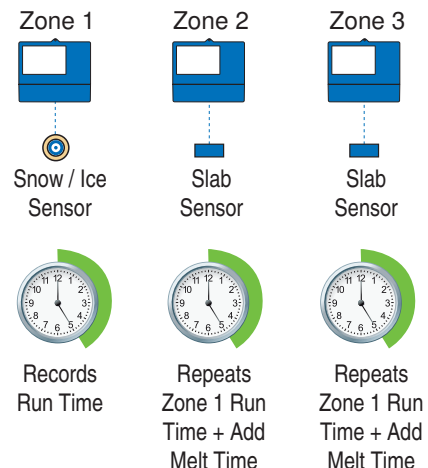

Idle Operation

When the snow melting system starts from a cold temperature, there may be a long time delay before the slab is warm enough to melt snow. This time delay allows snow to accumulate on the slab which is not acceptable in some commercial and institutional applications. To decrease the start-up time, the slab can be pre-heated to maintain a minimum temperature. This is known as the Idle temperature. Idling requires large energy consumption and is generally recommended for institutional and/or commercial installations where safety concerns are paramount. The display shows "System is Idling" when the control is in idle operation.

When designing a snow melting system, an engineer may specify the amount of allowed snow accumulation as the Snow-Free Area Ratio. There are three different levels. A Snow-Free Area Ratio of 1 is defined as a system that melts all snow as it falls with no allowed accumulation. This requires that the Idle temperature be set just below freezing. Examples of these types of applications include:

- Hospital emergency areas
- Helicopter landing pads
- Parking garage ramps

A Snow-Free Area Ratio of 0.5 is defined as a system with partial snow accumulation on the slab but not in all areas.

These types of systems may also use Idling but usually set at a temperature several degrees below freezing to reduce energy consumption. Applications may include:

- Steep residential driveways
- Commercial sidewalks
- Loading docks

A Snow-Free Area Ratio of 0 is defined as a system that allows snow accumulation. These systems operate the snow melting system from a cold start resulting in the lowest energy consumption costs and the longest times to start melting snow. In this case set the Idle to off. This is recommended for most residential applications such as:

- Flat residential driveways
- Patios
- Residential sidewalks

Some systems are designed for keeping a slab surface free of ice rather than free of snow. The most common applications include:

- Car wash bays and aprons
- Aircraft hanger aprons
- Turf conditioning on golf course greens

These systems require the use of Idling at or near freezing throughout the winter and may result in high energy consumption.

Storm Operation

The Storm operation combines the benefits of a fast response time together with lower operating costs. Typically the storm temperature is set below freezing to maximize energy savings. In the event that snow falls and is detected by a Snow/Ice Sensor or a Snow Sensor or the system is manually started, the snow melt system heats the slab up to the melting temperature and completes a melting cycle.

Should no snow fall during the storm time period, the control exits Storm operation and returns to Off.



The Storm operation is set up by setting the Storm temperature and the Storm Run Time in the Temperatures menu.

Auto Storm

The control automatically checks an Internet weather service to determine the snowfall forecast for a region based upon the US ZIP or Canadian postal code. When the Storm feature is on and snowfall is predicted, the control automatically heats the slab to the storm setting.

When connected using tekmarNet, a 670 can automatically start the storm operation on a Snow Melting Control 654. To do this set the 670 and the 654 to use the same Storm Group number.

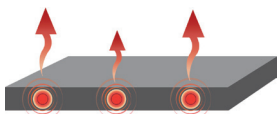
If  forecast

Then  

Manual Storm

The storm operation can be manually started by a User Switch 480 or 481 or a Gateway 482 or 485. The manual storm uses the Storm Group number in the tekmarNet menu.

Setup Procedure

Step 1: Set the 670 Storm Group number from 1 to 12. The default is 12.

Step 2: Set the User Switch or the Gateway to use the corresponding Storm Group number.

When the User Switch button is pressed, the 670 will enter the Storm Operation. Likewise, activating the Storm Group on the Gateway cause the 670 to enter the Storm Operation.

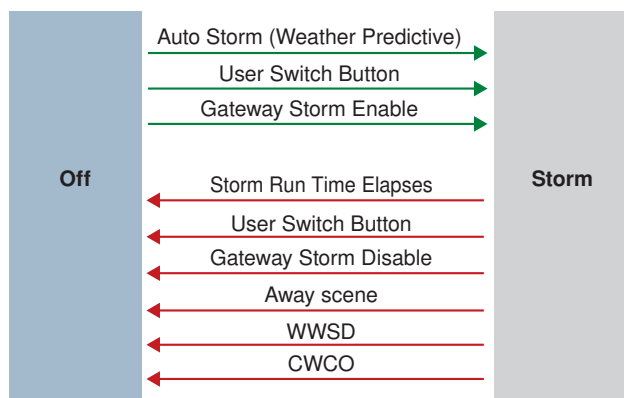

Slab Temperature Control

Controlling the slab temperature is critical to minimizing the cost of snow melting. This requires that either a Snow/Ice Sensor 090 or 094 or a Slab Sensor 072 or 073 is installed. The Snow/Ice Sensor contains a built-in slab temperature sensor. While the control can operate without a slab sensor installed, operating costs are much higher.

The slab is operated using slab outdoor reset. As the outdoor temperature gets colder, the heat loss of the slab increases. In order to keep the slab surface at a constant temperature while operating, the inner core of the slab must be heated above the melt, idle or storm temperature setting. The amount that the slab inner core temperature is above the melt, idle or storm setting is proportional to the outdoor temperature. Since the slab sensor is installed below the surface of the slab, it is not measuring the true slab surface temperature but rather the inner core temperature. The control automatically compensates for this temperature difference. The Slab item in

the Status menu displays the actual measured temperature, so it is normal to view slab temperatures that exceed the melt, idle, or storm temperature settings.

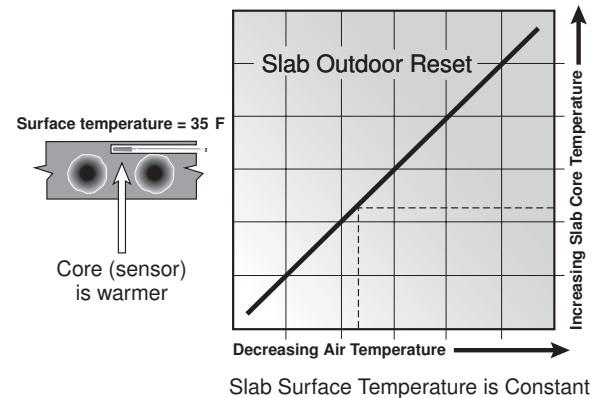

Slab Protection

In a hydronic snow melting system, the boiler or heating plant capacity may be much larger than the load of the snow melting zones. This can result in large temperature differentials between the supply water temperature and the slab creating large tensile stresses on the slab. Concrete is weak to tensile forces and when repeatedly exposed to tensile loads the concrete may crack. This may be prevented by selecting the Slab Protection setting in the System Setup menu to On. The control measures and limits the temperature differential between the supply water and the slab.

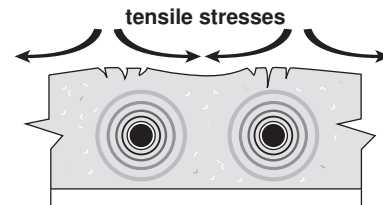

Snow Melt Zones and Priority

Dividing a system into a number of snow melting zones and prioritizing the zone operation reduces the size requirements of the hydronic heating plant or the amperage of the electrical service panel. This results in lower initial capital cost of the snow melting system. The trade off is that some snow melt zones may not be able to melt as soon as the snow fall begins and the user must tolerate snow accumulation on the slab. The snow melt system using Snow Melting Control 654 and 670 may have up to 12 snow melt zones. Zone 1 has the highest priority and zone 12 has the lowest. The priority setting in the tekmarNet[®] menu allows the installer to select the level of zone priority for the entire snow melt system. Changing the priority setting on one control will update on all other snow melt controls at the same time. The zone priority has 3 setting levels. There is some risk that lower priority zones may ice up when they are shut off by the higher priority zone. For example, if a high priority zone should finish melting and allow a lower priority zone to start melting, and then a new snow fall occurs, the high priority zone will shut off the lower priority zones. This may potentially allow the lower priority zones to ice over. The limitations of zoning and

using priority must be carefully considered and discussed with the building owners and occupants when designing the snow melting system.

Priority does not apply when the application mode is set to Boiler. In this mode, the boiler is dedicated to a single snow melting zone so priority is no longer applicable.

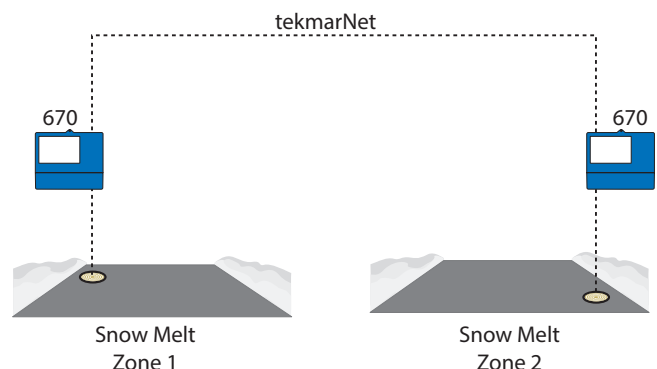

Hydronic Priority Levels

Priority = None

All zones have the same priority and can operate at the same time. This setting is recommended when the boiler plant capacity is sized larger than the heat loss of all zones at design conditions.

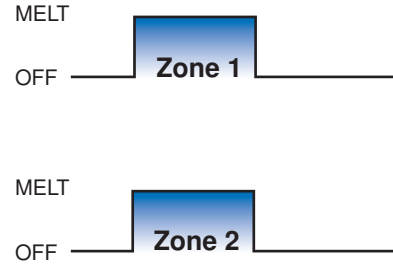

Priority = Conditional

The zone with the lower priority starts melting when the zone with higher priority is warm enough to melt snow or ice. This setting is recommended when the boiler plant capacity is sized to be larger than the heat loss of each zone with some extra capacity.

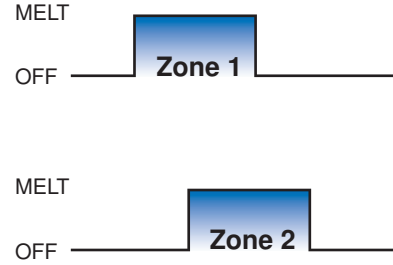

Priority = Full

The zone with the lower priority starts melting once the zone with higher priority has finished melting all snow or ice from the slab. This setting is recommended when the boiler plant capacity is sized to be the same as the heat loss of each zone at design conditions.

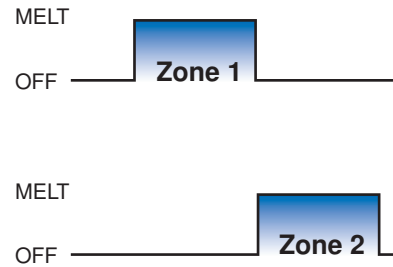

Electric Priority Levels

Electric snow melting offers three levels of priority: None, Conditional and Full. The None and Full priority options function the same as with the hydronic operation. The Conditional priority is unique to electrical operation. The highest priority zone operates first. Whenever the highest priority zone shuts

off its relay, the lower priority zone is allowed to start melting and close its relay. Only one electrical relay is allowed to be on at any time. This eliminates large instantaneous demands and avoids surcharges from the electrical utility.

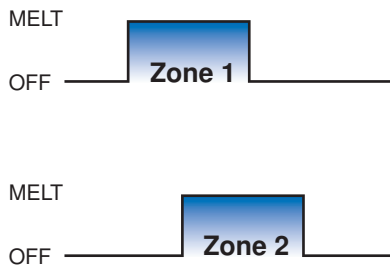

Zone 1 Relay



Zone 2 Relay

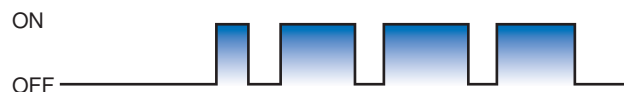

Warm Weather Shut Down

During warm weather, the slab is warm enough to naturally melt snow or ice. The control has a Warm Weather Shut Down (WWSD) setting in the Temperatures menu that prevents the control from entering Melt, Idle or Storm operation in order to conserve energy. The control shows, "System is Off – Warm Weather Shut Down" on the display when WWSD is in effect.

Automatic (Auto)

The control enters WWSD when both the slab temperature and the outdoor temperature exceed the Melting Setpoint temperature setting by more than 2°F (1°C).

Manual WWSD

The control enters WWSD when the outdoor air temperature exceeds the WWSD setting by 1°F (0.5°C) and when the slab temperature exceeds 34°F (1°C). The control exits WWSD when the outdoor air temperature falls 1°F (0.5°C) below the WWSD setting or if the slab temperature falls below 34°F (1°C). This allows the Melting Setpoint setting to be set higher than the WWSD. This is useful when high slab temperatures are required to melt the snow or ice. An example of this are installations using paving bricks on top of sand and concrete layers.

Cold Weather Cut Off

Maintaining the melting or idling setpoint temperature during extremely cold temperatures is not only expensive but may be impossible if the heat loss of the slab exceeds the input capacity of the heating plant or electric cable. When the outdoor air temperature drops below the Cold Weather Cut Off (CWCO) temperature **and** the slab is below freezing, the control does not operate the boiler but the system pump continues to run. This is a safety and energy saving measure. The control shows, "System is Off – Cold Weather Cut Off" on the display when CWCO is in effect. If the snow melting

system is operating, and the outdoor air temperature falls below the CWCO setting **and** the slab is above freezing, then it continues melting and stops once the slab is dry. When the temperature reaches the CWCO setting in an actively melting system with an 090 or 094, melting is suspended until the outdoor temperature rises above the CWCO setting at which time melting is resumed. If an 090 or 094 is not installed, melting is permanently stopped when CWCO is in effect and melting does not resume when the temperature rises above the CWCO setting.

Time Clock

The control has a built-in time clock that can be set manually or automatically by the Internet. A battery-less backup allows the control to keep time for up to 4 hours without power. The time clock supports automatic adjustment for Daylight Saving

Time (DST) once the day, month and year are entered. Use the Time menu to set the correct time, day, month and year. If the time and date is set incorrectly, the control may be unable to communicate to the mobile app.

Away Operation

While on vacation and away from a building, it may not be necessary to operate the snow melting system. The away feature allows the user to shut off the snow melting system to maximize energy savings. The Away feature can be activated through the:

- Away menu
- tekmar Connect mobile app
- tekmarNet User Switch 480 or 481
- tekmarNet Gateway 482 or 485

tekmarNet Scene Operation

The tekmarNet system supports up to 8 scenes.

The 670 supports tekmarNet scenes 1 (normal operation) and 2 (away).

During tekmarNet scenes 3 through 8, the 670 remains in scene 1 (normal operation).

Application Modes

The snow melting control can operate either an electric or a hydronic snow melting system. A hydronic system can be categorized as boiler, mixing, boiler and mixing, or pulse width modulation zone operation. A dedicated boiler only provides heat for the snow melting system. A shared boiler provides heat for the snow melting system in addition to the space heating and/or a domestic hot water system. These choices affect which Application Mode is selected in the System Setup menu:

- | | |
|--------------|---------------------------------------|
| • PWM Zone | Pulse Width Modulation Zone Operation |
| • Boiler | Boiler Operation |
| • Mixing | Mixing Operation |
| • Boiler+Mix | Boiler and Mixing Operation |
| • Electric | Electrical Operation |

Electric Operation

The Application Mode should be set to Electric when operating an electric heating cable. The control operates the heat relay on a 20-minute pulse width modulation cycle. The heat relay in turn activates a line voltage electrical contactor to energize the electrical cable heater installed in the slab. The relay on time is determined by the calculated slab target and by the measured slab temperature reading. As the slab temperature reaches the slab target, the on-time per cycle of the relay is reduced to prevent the slab temperature from overshooting. If no slab sensor is installed the relay remains on 100% of the time until the Melt operation has completed. Idle and Storm operation are not available when a slab sensor is not installed. The electric operation requires the installation of an outdoor sensor. A slab sensor is highly recommended in order to reduce operating costs.

Relay operation:

- Heat relay — cycles on and off using Pulse Width Modulation
- System pump — not used
- Primary pump — not used
- Boiler stage 1 — not used
- Boiler stage 2 — not used

Pulse Width Modulation Zone Operation

The Application Mode should be set to Pulse Width Modulation (PWM) Zone when the snow melting system is warmed from a heat source that is shared with other loads in a building.

The control operates the system pump to operate continuously during melt, idle and storm operation. The boiler stage 1 relay operates on a 20-minute pulse width modulation cycle. The relay on time is determined by the calculated slab target and by the measured slab temperature reading. As the slab temperature reaches the slab target, the on time per cycle of the relay is reduced to prevent the slab temperature from overshooting. If no slab sensor is installed the heat relay remains on 100% of the time until the Melt operation has completed. Idle and Storm operation are not available when a slab sensor is not installed. The PWM Zone operation requires the installation of an outdoor sensor. A slab sensor is highly recommended in order to reduce operating costs.

Relay operation:

- System pump — operates continuously during melting, idling or storm
- Heat relay — cycles on/off using Pulse Width Modulation to control the slab temperature
- Boiler stage 1 — cycles on/off using Pulse Width Modulation to control the slab temperature
- Boiler stage 2 — not used

Boiler Operation

The Application Mode should be set to Boiler when the snow melting system has a dedicated boiler or heat source and there is no mixing device. The boiler is piped primary-secondary to the snow melting loop, thereby allowing the boiler to fire on and off while allowing continuous flow through the snow melting system loop. The control calculates a Boiler Target based upon the Slab Target, which in turn is based upon the measured outdoor temperature and the Melt, Idle or Storm temperature setting. The boiler is fired to maintain the Boiler Target at the Boiler Supply Sensor location. The control can operate a boiler in one of four different methods: modulating boiler, 1 stage, 2 stage and EMS. The Boiler Target is shown in the System Status menu. Settings for the boiler operation are located in the Boiler Setup menu.

1 Stage Boiler

The control turns the boiler stage 1 relay on or off to fire the boiler and maintain the Boiler Target temperature. The boiler supply temperature operates on a differential that is half above and half below the boiler target. The status of the boiler is shown in the System Status menu.

2 Stage Boiler

The control turns the boiler stage 1 and 2 relays on or off to fire a single boiler in order to maintain the Boiler Target temperature. The boiler supply temperature operates on a differential that is half above and half below the boiler target. The boiler staging is operated automatically using PID logic. The status of the boiler stages 1 and 2 is shown in the System Status menu.

Modulating Boiler

The control can operate a single modulating boiler using the modulating output and the boiler stage 1 contact. The control operates the boiler by first switching the boiler stage 1 contact to allow the modulating boiler to go through the ignition sequence. The boiler stage 1 contact may not be required on all modulating boilers. A 0-10 V (dc) or 4-20 mA analog signal is then used to modulate the boiler firing rate starting at 50% (5 V (dc) or 12 mA signal) for 30 seconds. After the 30-second delay has elapsed, the control will then allow the boiler to modulate down to the Boiler Minimum Modulation setting and hold it there for the Boiler Modulation Delay time setting. After the modulation delay has elapsed, the control uses PID logic to change the boiler firing rate signal in order to satisfy the boiler target temperature. When the firing rate signal is reduced down to the minimum modulating setting and the boiler supply temperature exceeds the boiler target by 1/2 of the differential, the control will shut off the boiler burner. The modulating signal output is shown by the Boiler Output in the System Status menu.

The Boiler Modulation Delay setting is determined by the boiler manufacturer. It is the amount of time that the burner must operate before the internal boiler control allows an external signal to operate the burner.

The Boiler Motor Speed sets the rate at which the modulating electrical signal can change. For most modulating boilers with an ECM fan, the boiler motor speed can be set to 30 seconds. For commercial boilers with a mod motor, set the boiler motor speed according to the time required by the mod motor to travel from the closed to open position.

EMS

When the boiler is required to operate, the control's boiler modulation output is adjusted to an appropriate analog signal corresponding to the boiler target temperature and then turns on the boiler stage 1 relay. The analog signal is proportional to the boiler target in a linear line defined by the EMS Signal Minimum, the EMS Low Temperature, and the EMS High Temperature settings.

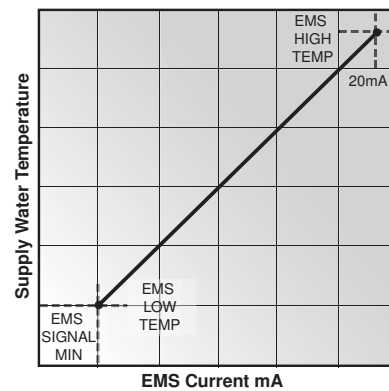
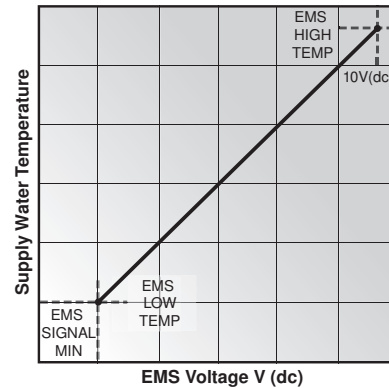

Relay operation:

System pump — operates continuously during melting, idling or storm

Heat relay — not used

Boiler stage 1 — cycles on/off based on boiler target

Boiler stage 2 — cycles on/off based on boiler target when using a two-stage boiler, otherwise off.

Mod Boiler — a signal ranges between 0-10 V (dc) or 4-20 mA

NOTICE

The boiler operator, or aquastat, remains in the burner circuit and acts as a secondary upper limit on the boiler temperature. It is recommended to set the boiler aquastat temperature to at least 180°F (82.0°C) in order to prevent short cycling of the burner.

Mixing Operation

The Application Mode should be set to Mixing when a mixing valve or a mixing injection pump is installed with a shared boiler plant. Four mixing options are available:

- Floating action mixing valve
- Variable-speed injection pump
- Analog mixing using 0-10 V (dc)
- Analog mixing using 4-20 mA

The control calculates the Slab Target temperature based on the outdoor air temperature and the Melting, Idling or Storm Setpoint. The control then determines the Mix System Target based on the Slab Target requirements. The Mix Maximum setting limits the upper temperature of the Mix System Target. The Mix System Target is shown in the System Status menu.

For design and sizing of the variable-speed injection mixing pump, please refer to the Essay E021.

Relay operation:

- System pump — operates continuously during melting, idling or storm

- Heat relay — closes when the mixing valve is open or the variable speed injection pump is operating.
- Boiler stage 1 — turns on when the valve is open or the variable speed injection pump is operating.

• Boiler stage 2 — not used

If using Floating Action Mixing

- Floating action open — contact closes momentarily when pulsing actuator open
- Floating action closed — contact closes momentarily when pulsing actuator closed

If using Variable Speed Injection Mixing

- Injection Mixing Output — a variable speed signal is supplied to the pump

If using Analog Mixing

- Analog Mixing Output — a signal ranges between 0-10 V (dc) or 4 -20 mA

Boiler and Mixing Operation

The Application Mode should be set to Boiler+Mix when a mixing valve or a mixing injection pump is installed to regulate the supply water temperature to the snow melting system with a dedicated boiler plant. In this case, the control operates both the mixing device and the dedicated boiler at the same time.

The control calculates the Slab Target temperature based on the outdoor air temperature and the Melting, Idling or Storm Setpoint. The control then determines the Mix System Target based on the Slab Target requirements. The control then determines the required Boiler Target that is required to meet the Mix System Target. Refer to the Boiler and Mixing Operation sections for detailed information on the boiler and mixing operation.

Relay operation:

- System pump — operates continuously during melting, idling or storm
- Heat relay — not used

- Boiler stage 1 — cycles on/off based on boiler target
- Boiler stage 2 — cycles on/off based on boiler target when using a two-stage boiler, otherwise off.

If using Floating Action Mixing

- Floating action open — contact closes momentarily when pulsing actuator open
- Floating action closed — contact closes momentarily when pulsing actuator closed

If using Variable Speed Injection Mixing

- Injection Mixing Output — a variable speed signal is supplied to the pump

If using Analog Mixing

- Analog Mixing Output — a signal ranges between 0-10 V (dc) or 4 -20 mA

Outdoor Sensor

The outdoor air temperature is required for all application modes. The control has the option to measure an outdoor air sensor or the outdoor temperature can be provided through

the tekmarNet system or through the Internet weather service. This is selected by the Outdoor Sensor setting in the System Setup menu.

Exercising

In a hydronic snow melting system, the control operates the system, primary, boiler, variable speed injection mixing pump and mixing valve every 3 days to prevent pump and valve seizure.

Post Purge

The boiler or heat source is shut off and the snow melting system continues to operate for 20 seconds to post purge heat from the boiler to the load.

Troubleshooting

It is recommended to complete all wiring to ensure trouble free operation. Should an error occur, simply follow these steps:



1. **Find:** If the control shows the Warning Symbol  on the screen, it is indicating a problem on the system.
2. **Identify:** Press the Warning Symbol to view the error code.
3. **Solve:** Use the chart below to match the error code to the one on the control. Use the description to solve the problem.

Error Messages (1 of 4)
Description
<p>TEMPERATURE MENU SAVE ERROR The control failed to read the Temperatures menu settings from memory and has reloaded the factory default settings. The control stops operation until all settings in the Temperatures menu are checked. To clear the error, set the access level to Installer and check all settings in the Temperatures menu.</p>
<p>SYSTEM SETUP MENU SAVE ERROR The control failed to read the System Setup menu settings from memory and has reloaded the factory default settings. The control stops operation until all settings in the System Setup menu are checked. To clear the error, set the access level to Installer and check all settings in the System Setup menu.</p>
<p>BOILER SETUP MENU SAVE ERROR The control failed to read the Boiler Setup menu settings from memory and has reloaded the factory default settings. The control stops operation until all settings in the Boiler Setup menu are checked. To clear the error, set the access level to Installer and check all settings in the Boiler Setup menu.</p>
<p>MIXING SETUP MENU SAVE ERROR The control failed to read the Mixing Setup menu settings from memory and has reloaded the factory default settings. The control stops operation until all settings in the Mixing Setup menu are checked. To clear the error, set the access level to Installer and check all settings in the Mixing Setup menu.</p>
<p>tekmarNet MENU SAVE ERROR The control failed to read the tekmarNet menu settings from memory and has reloaded the factory default settings. The control stops operation until all settings in the tekmarNet menu are checked. To clear the error, set the access level to Installer and check all settings in the tekmarNet menu.</p>
<p>WiFi MENU SAVE ERROR The control failed to read the WiFi menu settings from memory and has reloaded the factory default settings. The control stops operation until all settings in the WiFi menu are checked. To clear the error, set the access level to Installer and check all settings in the WiFi menu.</p>
<p>MAX MELT DAYS ERROR The control has operated in melting for the time set by Maximum Melt Days setting located in the System Setup menu. This error is usually created when there is a mechanical system failure resulting in the snow melt slab not heating correctly. Clear the error message by touching the Cancel button while viewing the error message. Use the Manual Override menu to manually check that each component of the mechanical system is operating correctly. If necessary, change the Maximum Melt Days setting to a longer time period or to Off.</p>
<p>OUTDOOR SENSOR OPEN CIRCUIT ERROR Due to an open circuit, the control is unable to read the Outdoor Sensor 070 on terminals 16 and 18. This error may also occur when using the outdoor temperature from a tekmarNet system. The control continues to operate and assumes an outdoor temperature of 32°F (0°C). Energy saving features such as Warm Weather Shut Down (WWSD) and Cold Weather Cut Off (CWCO) are disabled. Check the outdoor sensor wire for open circuits according to the sensor installation manual. It may be necessary to replace the outdoor sensor. Once the error has been corrected, the error message automatically clears.</p>
<p>OUTDOOR SENSOR SHORT CIRCUIT ERROR Due to a short circuit, the control is unable to read the Outdoor Sensor 070 on terminals 16 and 18. The control continues to operate and assumes an outdoor temperature of 32°F (0°C). Energy saving features such as Warm Weather Shut Down (WWSD) and Cold Weather Cut Off (CWCO) are disabled. Check the outdoor sensor wire for short circuits according to the sensor installation manual. It may be necessary to replace the outdoor sensor. Once the error has been corrected, the error message automatically clears.</p>

Error Messages (2 of 4)

Description

MIX SUPPLY SENSOR OPEN CIRCUIT ERROR

Due to an open circuit, the control is unable to read the Mix Supply Sensor 082 on terminals 15 and 16. The control stops operation and does not provide any heat.

Check the system supply sensor wire for open circuits according to the sensor installation manual. It may be necessary to replace the mix supply sensor. Once the error has been corrected, the error message automatically clears.

MIX SUPPLY SENSOR SHORT CIRCUIT ERROR

Due to a short circuit, the control is unable to read the Mix Supply Sensor 082 on terminals 15 and 16. The control stops operation and does not provide any heat.

Check the system supply sensor wire for short circuits according to the sensor installation manual. It may be necessary to replace the mix supply sensor. Once the error has been corrected, the error message automatically clears.

BOILER SENSOR OPEN CIRCUIT ERROR

Due to an open circuit, the control is unable to read the Boiler Sensor 082 on terminals 16 and 17. When application mode is set to boiler or boiler+mix the control stops operation. In all other application modes, the control continues to heat the snow melting system but does not control the boiler operating temperature.

Check the boiler sensor wire for open circuits according to the sensor installation manual. It may be necessary to replace the boiler sensor. Once the error has been corrected, the error message automatically clears.

BOILER SENSOR SHORT CIRCUIT ERROR

Due to a short circuit, the control is unable to read the Boiler Sensor 082 on terminals 16 and 17. When application mode is set to boiler or boiler+mix the control stops operation. In all other application modes, the control continues to heat the snow melting system but does not control the boiler operating temperature.

Check the boiler sensor wire for short circuits according to the sensor installation manual. It may be necessary to replace the boiler supply sensor. Once the error has been corrected, the error message automatically clears.

SLAB SENSOR OPEN CIRCUIT ERROR

Due to an open circuit, the control is unable to read the Slab Sensor 072 or 073 on terminals 7 and 10. Idling and storm are disabled and energy saving features such as Warm Weather Shut Down (WWSD) and Cold Weather Cut Off (CWCO) are operated using the outdoor temperature only.

Check the slab sensor wire for open circuits according to the sensor installation manual. It may be necessary to replace the slab sensor. Once the error has been corrected, the error message automatically clears.

If the slab sensor has been intentionally removed, set the slab sensor setting in the system setup menu to off.

SLAB SENSOR SHORT CIRCUIT ERROR

Due to a short circuit, the control is unable to read the Slab Sensor 072 or 073 on terminals 7 and 10. Idling and Storm are disabled and energy saving features such as Warm Weather Shut Down (WWSD) and Cold Weather Cut Off (CWCO) are operated using the outdoor temperature only.

Check the slab sensor wire for short circuits according to the sensor installation manual. It may be necessary to replace the slab sensor. Once the error has been corrected, the error message automatically clears.

SNOW SENSOR YELLOW WIRE OPEN CIRCUIT ERROR

Due to an open circuit, the control is unable to read the yellow wire connected to the Snow/Ice Sensor 090 or 094, or the Snow Sensor 095 on terminals 7 and 9. The control can no longer automatically detect snow or ice, but manual start of the snow melting system is still available.

Check the snow/ice sensor or snow sensor yellow and black wires and any wire splices for open circuits according to the sensor installation manual. It may be necessary to replace the sensor. Once the error has been corrected, the error message automatically clears.

SNOW SENSOR BLUE WIRE OPEN CIRCUIT ERROR

Due to an open circuit, the control is unable to read the blue wire connected to the Snow/Ice Sensor 090 or 094, or the Snow Sensor 095 on terminals 7 and 8. The control can no longer automatically detect snow or ice, but manual start of the snow melting system is still available.

Check the snow/ice sensor or snow sensor blue and black wires and any wire splices for open circuits according to the sensor installation manual. It may be necessary to replace the sensor. Once the error has been corrected, the error message automatically clears.

SNOW SENSOR BLUE WIRE SHORT CIRCUIT ERROR

Due to a short circuit, the control is unable to read the blue wire connected to the Snow/Ice Sensor 090 or 094, or the Snow Sensor 095 on terminals 7 and 8. The control can no longer automatically detect snow or ice, but manual start of the snow melting system is still available.

First check the snow/ice sensor or snow sensor for dirt or debris. The ring structure of the sensor may need cleaning with hot soapy water and a nylon brush. Rinse with water. Second, check the snow/ice sensor or snow sensor blue and black wires and any wire splices for short circuits according to the sensor installation manual. It may be necessary to replace the sensor. Once the error has been corrected, the error message automatically clears.

Error Messages (3 of 4)

Description

SNOW SENSOR BROWN WIRE OPEN CIRCUIT ERROR

Due to an open circuit, the control is unable to read the brown wire connected to the Snow/Ice Sensor 090 or 094 on terminals 7 and 10. Idling and Storm is disabled and energy saving features such as Warm Weather Shut Down (WWSD) and Cold Weather Cut Off (CWCO) are operated using the outdoor temperature only.

Check the snow/ice sensor brown and black wires for open circuits according to the sensor installation manual. It may be necessary to replace the sensor. Once the error has been corrected, the error message automatically clears.

SNOW SENSOR BROWN WIRE SHORT CIRCUIT ERROR

Due to a short circuit, the control is unable to read the brown wire connected to the Snow/Ice Sensor 090 or 094 on terminals 7 and 10. Idling and Storm is disabled and energy saving features such as Warm Weather Shut Down (WWSD) and Cold Weather Cut Off (CWCO) are operated using the outdoor temperature only.

Check the snow/ice sensor brown and black wires for short circuits according to the sensor installation manual. It may be necessary to replace the sensor. Once the error has been corrected, the error message automatically clears.

SNOW/ICE SENSOR ERROR

The control is unable to properly detect the Snow/Ice Sensor 090 or 094 on terminals 6, 7, 8, 9 and 10. The control can no longer automatically detect snow or ice, but manual start of the snow melting system is still available.

Check the snow/ice sensor brown, yellow, red and black wires according to the sensor installation manual. It is important to check any cable splices for loose wiring connections. It may be necessary to replace the sensor. Once the error has been corrected, the error message automatically clears.

SNOW SENSOR ERROR

The control is unable to properly detect the Snow Sensor 095 on terminals 6, 7, 8, and 9. The control can no longer automatically detect snow but manual start of the snow melting system is still available.

Check the snow sensor yellow, red and black wires according to the sensor installation manual. It may be necessary to replace the sensor. Once the error has been corrected, the error message automatically clears.

SCENES MENU SAVE ERROR

The control failed to read the Scenes menu settings from memory and has reloaded the factory default settings. The control operates with the away scene disabled until all settings in the Scenes menu are checked.

To clear the error, set the access level to Installer and check all settings in the Scenes menu.

tekmarNet® COMMUNICATION ERROR

The tekmarNet® communication bus has either an open or a short circuit. The result is that there are no communications. Check for loose wires between tN4 and C. Check for short circuits between the tN4 and C wires on the House Control, Wiring Center, or Zone Manager. Check for correct polarity between the C and R wires. The error clears automatically once the wiring fault has been corrected. To force the error to clear while allowing a short or open circuit to continue, touch the Cancel key.

ADDRESS TAKEN ERROR

Two devices (thermostats, setpoint controls, snow melting controls) have been manually set to the same address. The device continues to operate with this error but does not communicate with the tekmarNet® system.

To clear this error, select an unused tekmarNet® address or select automatic addressing.

SNOW ZONE TAKEN ERROR

Two snow melting controls have been manually set to the same snow zone number and one of the controls is NOT set to App Mode 090. The control continues to operate with this error.

To clear this error, select an unused snow zone number or set the App Mode to 090.

TANDEM 090 ERROR

There are two Snow / Ice Sensors 090 or 094 installed in the zone and the other snow melting control's 090 or 094 has a sensor problem. Locate the other snow melting control and navigate to the Toolbox menu to determine and correct the problem. The control continues to operate with this error.

ERROR AT THERMOSTAT

There is an error on a different thermostat or setpoint control connected to the tekmarNet® system and not on this control.

01 to 24 = There is an error on a thermostat or setpoint control with this tekmarNet® address.

ERROR AT THERMOSTAT

There is an error on a different thermostat or setpoint control connected to the tekmarNet® system and not on this control.

b:01 to b:24 = There is an error on a thermostat or setpoint control wired to the boiler communication bus with this tekmarNet® address.

ERROR AT THERMOSTAT

There is an error on a different thermostat or setpoint control connected to the tekmarNet® system and not on this control.

1:01 to 1:24 = There is an error on a thermostat or setpoint control wired to communication bus 1 with this tekmarNet® address.

Error Messages (4 of 4)

Description

ERROR AT THERMOSTAT

There is an error on a different thermostat or setpoint control connected to the tekmarNet® system and not on this control.
2:01 to 2:24 = There is an error on a thermostat or setpoint control wired to communication bus 2 with this tekmarNet® address.

ERROR AT THERMOSTAT

There is an error on a different thermostat or setpoint control connected to the tekmarNet® system and not on this control.
3:01 to 3:24 = There is an error on a thermostat or setpoint control wired to the mix 3 bus with this tekmarNet® address.

ERROR AT SYSTEM CONTROL

There is an error on the tekmarNet® system control connected to the tekmarNet® system and not on this control.

Frequently Asked Questions

Symptom	Look For...	Corrective Action
Touchscreen is off	Power to control	Use electrical meter to measure 115 V (ac) voltage on input power L and N terminals.
System pump always on	Display shows Idle	Idle operation requires that the system pump operate continuously while below the melting temperature setting.
Blue short	Dirt or salt on snow/ice sensor	The snow/ice sensor requires regular cleaning. Avoid using road salt on the snow melting slab.
Slab is above melt temperature	Slab Target	The slab is heated to the slab target.
System running with no snow	System is Idling	Idling heats the slab when the temperature falls below the Idle temperature.
	System is Melting	During cold weather cut off (CWCO), the system is shut off. If it shuts off during a melt cycle, the system resumes melting once the outdoor temperature is above CWCO.
	Remaining Run Time	System manually started.
	Slab and Slab Target	The slab must reach the slab target temperature in order for the system to shut off. Lower the cold weather cut off (CWCO) or increase the boiler aquastat setting.
Snow on slab but system did not start	System is Off	System has been manually stopped and the automatic snow/ice sensor never dried, thereby preventing the system from automatically starting.
Cannot register device	Check WiFi signal strength	May need to move the control or router a few inches in any direction.
Cannot connect to WiFi	Check WiFi signal strength	May need to move the control or router a few inches in any direction.

WARNING: This product contains chemicals known to the State of California to cause cancer and birth defects or other reproductive harm.
For more information: Watts.com/prop65

Technical Data

WiFi Snow Melting Control 670 Boiler & Mixing / Electric	
Literature	670_A, 670_C, 670_D, 670_J, 670_U
Control	Microprocessor control. This is not a safety (limit) control.
Packaged weight	4.3 lb. (1960 g)
Dimensions	6-5/8" H x 7-9/16" W x 2-13/16" D (170 x 193 x 72 mm)
Display	3.5", color touchscreen
Enclosure	Blue PVC plastic, NEMA type 1
Approvals	CSA C US, meets class B: ICES & FCC Part 15
Ambient conditions	-4 to 122°F (-20 to 50°C), < 90% RH non-condensing, outdoor use permitted when used in NEMA 3 enclosure
Power supply	115 V (ac) ±10%, 60 Hz, 20 VA
Relays	230 V (ac), 5 A, 1/3 hp
Boiler modulating output	0-10 V (dc) 500 Ω min impedance / 4-20 mA 1 kΩ max impedance
Injection mixing pump	230 V (ac), 2.4 A 1/6 hp, fuse T2.5 A 250V
Floating mixing output	230 V (ac), 5 A
Analog mixing output	0-10 V (dc) 500 Ω min impedance / 4-20 mA 1 kΩ max impedance
Manual melt call	Short or 0 - 32 V(ac)
Communications	WiFi 802.11n, 2.4 GHz, WPA2 encryption
Mobile app	Apple iOS 12 or higher, Android 8 or higher
Sensors	NTC thermistor, 10 kΩ @ 77°F (25°C ±0.2°C) β=3892
–Included	Outdoor Sensor 070 and 2 of Universal Sensor 082
–Optional	tekmar type: 072, 073, 082, 090, 094, 095

Limited Warranty and Product Return Procedure

Limited Warranty *The liability of tekmar under this warranty is limited. The Purchaser, by taking receipt of any tekmar product ("Product"), acknowledges the terms of the Limited Warranty in effect at the time of such Product sale and acknowledges that it has read and understands same.*

The tekmar Limited Warranty to the Purchaser on the Products sold hereunder is a manufacturer's pass-through warranty which the Purchaser is authorized to pass through to its customers. Under the Limited Warranty, each tekmar Product is warranted against defects in workmanship and materials if the Product is installed and used in compliance with tekmar's instructions, ordinary wear and tear excepted. The pass-through warranty period is for a period of twenty-four (24) months from the production date if the Product is not installed during that period, or twelve (12) months from the documented date of installation if installed within twenty-four (24) months from the production date.

The liability of tekmar under the Limited Warranty shall be limited to, at tekmar's sole discretion: the cost of parts and labor provided by tekmar to repair defects in materials and / or workmanship of the defective product; or to the exchange of the defective product for a warranty replacement product; or to the granting of credit limited to the original cost of the defective product, and such repair, exchange or credit shall be the sole remedy available from tekmar, and, without limiting the foregoing in any way, tekmar is not responsible, in contract, tort or strict product liability, for any other losses, costs, expenses, inconveniences, or damages, whether direct, indirect, special, secondary, incidental or consequential, arising from ownership or use of the product, or from defects in workmanship or materials, including any liability for fundamental breach of contract.

The pass-through Limited Warranty applies only to those defective Products returned to tekmar during the warranty period. This Limited Warranty does not cover the cost of the parts or labor to remove or transport the defective Product, or to reinstall the repaired or replacement Product, all such costs and expenses being subject to Purchaser's agreement and warranty with its customers.

Any representations or warranties about the Products made by Purchaser to its customers which are different from or in excess of the tekmar Limited Warranty are the Purchaser's sole responsibility and obligation. Purchaser shall indemnify and hold

tekmar harmless from and against any and all claims, liabilities and damages of any kind or nature which arise out of or are related to any such representations or warranties by Purchaser to its customers.

The pass-through Limited Warranty does not apply if the returned Product has been damaged by negligence by persons other than tekmar, accident, fire, Act of God, abuse or misuse; or has been damaged by modifications, alterations or attachments made subsequent to purchase which have not been authorized by tekmar; or if the Product was not installed in compliance with tekmar's instructions and / or the local codes and ordinances; or if due to defective installation of the Product; or if the Product was not used in compliance with tekmar's instructions.

THIS WARRANTY IS IN LIEU OF ALL OTHER WARRANTIES, EXPRESS OR IMPLIED, WHICH THE GOVERNING LAW ALLOWS PARTIES TO CONTRACTUALLY EXCLUDE, INCLUDING, WITHOUT LIMITATION, IMPLIED WARRANTIES OF MERCHANTABILITY AND FITNESS FOR A PARTICULAR PURPOSE, DURABILITY OR DESCRIPTION OF THE PRODUCT, ITS NON-INFRINGEMENT OF ANY RELEVANT PATENTS OR TRADEMARKS, AND ITS COMPLIANCE WITH OR NON-VIOLATION OF ANY APPLICABLE ENVIRONMENTAL, HEALTH OR SAFETY LEGISLATION; THE TERM OF ANY OTHER WARRANTY NOT HEREBY CONTRACTUALLY EXCLUDED IS LIMITED SUCH THAT IT SHALL NOT EXTEND BEYOND TWENTY-FOUR (24) MONTHS FROM THE PRODUCTION DATE, TO THE EXTENT THAT SUCH LIMITATION IS ALLOWED BY THE GOVERNING LAW.

Product Warranty Return Procedure All Products that are believed to have defects in workmanship or materials must be returned, together with a written description of the defect, to the tekmar Representative assigned to the territory in which such Product is located. If tekmar receives an inquiry from someone other than a tekmar Representative, including an inquiry from Purchaser (if not a tekmar Representative) or Purchaser's customers, regarding a potential warranty claim, tekmar's sole obligation shall be to provide the address and other contact information regarding the appropriate Representative.

Need help? Go to our website or contact us.

tekmarControls.com | tekmar.customerservice@wattswater.com | 1-800-438-3903

tekmar[®]

A WATTS Brand